

HW-H550
HW-H551

Wireless Audio -
Soundbar
(Active Speaker System)
user manual

imagine the possibilities

Thank you for purchasing this Samsung product.
To receive more complete service,
please register your product at
www.samsung.com/register

This Nanum Gothic Eco font is provided by NAVER.



features

SoundConnect

SoundConnect lets you play TV audio from a Bluetooth compliant Samsung TV on your Wireless Audio - Soundbar via a Bluetooth connection, and control the sound.

HDMI

HDMI transmits video and audio signals simultaneously, and provides a clearer picture.

The unit is also equipped with the ARC function which lets you listen to sound from your TV via an HDMI cable through the Wireless Audio - Soundbar. This function is only available if you connect the unit to an ARC compliant TV.

Surround Sound

The Surround Sound feature adds depth and spaciousness to your listening experience.

Wireless Subwoofer

Samsung's wireless module does away with cables running between the main unit and the subwoofer. Instead, the subwoofer connects to a compact wireless module that communicates with the main unit.

Special Sound mode

You can select from 5 different sound modes - MUSIC, VOICE, SPORTS, CINEMA, and STANDARD - depending on the type of content you want to enjoy.

Multi-function Remote Control

You can use the remote control supplied with your Soundbar to control the TV connected to this unit. (Works only for Samsung TVs.)

The remote control has a TV hotkey that enables you to perform various operations with the simple press of a button.

Active Speaker System

This unit features an Active Speaker System that provides high sound quality in a single, slim unit.

This unit does not require any satellite loudspeakers or speaker cabling, which are normally required by conventional surround sound systems.

USB Host support

You can connect and play music files from external USB storage devices such as MP3 players, USB thumb drives, etc. using the Soundbar's USB HOST function.

Bluetooth Function

You can connect a Bluetooth device to the Soundbar and enjoy music in high quality stereo, all without wires!

LICENSE



Manufactured under license from Dolby Laboratories. Dolby and the double-D symbol are trademarks of Dolby Laboratories.



For DTS patents, see <http://patents.dts.com>. Manufactured under license from DTS Licensing Limited. DTS, the Symbol, &DTS and the Symbol together are registered trademarks, and DTS 2.0 Channel is a trademark of DTS, Inc. © DTS, Inc. All Rights Reserved.

HDMI



The terms HDMI and HDMI High-Definition Multimedia Interface, and the HDMI Logo are trademarks or registered trademarks of HDMI Licensing LLC in the United States and other countries.

- To send inquiries and requests regarding open sources, contact Samsung via Email (oss.request@samsung.com).

safety information

SAFETY WARNINGS

TO REDUCE THE RISK OF ELECTRIC SHOCK, DO NOT REMOVE THE COVER (OR BACK). NO USER-SERVICEABLE PARTS ARE INSIDE. REFER SERVICING TO QUALIFIED SERVICE PERSONNEL.

	<div style="border: 1px solid black; padding: 5px; text-align: center;"> <p>CAUTION</p> <p>RISK OF ELECTRIC SHOCK DO NOT OPEN</p> </div>	
<p>The lightning flash and Arrowhead within the triangle are warning signs alerting you to dangerous voltage inside the product.</p>	<p>CAUTION: TO REDUCE THE RISK OF ELECTRIC SHOCK, DO NOT REMOVE THE COVER (OR BACK). NO USER SERVICEABLE PARTS INSIDE. REFER SERVICING TO QUALIFIED SERVICE PERSONNEL.</p>	<p>The exclamation point within the triangle is a warning sign alerting you to important instructions accompanying the product.</p>

WARNING

- To reduce the risk of fire or electric shock, do not expose this appliance to rain or moisture.
- To prevent injury, this apparatus must be securely attached to the floor/wall in accordance with the installation instructions.

CAUTION

- Do not expose this apparatus to dripping or splashing. Do not put objects filled with liquids, such as vases on the apparatus.
- To turn this apparatus off completely, you must pull the power plug out of the wall socket. Consequently, the power plug must be easily and readily accessible at all times.

This product satisfies FCC regulations when shielded cables and connectors are used to connect the unit to other equipment. To prevent electromagnetic interference with electric appliances, such as radios and televisions, use shielded cables and connectors for connections.

FCC NOTE (for U.S.A):

This equipment has been tested and found to comply with the limits for a Class B digital device, pursuant to Part 15 of the FCC Rules. These limits are designed to provide reasonable protection against harmful interference in a residential installation.

This equipment generates, uses and can radiate radio frequency energy and, if not installed and used in accordance with the instructions, may cause harmful interference to radio communications. However, there is no guarantee that interference will not occur in a particular installation.

If this equipment does cause harmful interference to radio or television reception, which can be determined by turning the equipment off and on, the user is encouraged to try to correct the interference by one or more of the following measures:

- Reorient or relocate the receiving antenna.
- Increase the separation between the equipment and receiver.
- Connect the equipment to an outlet that is on a different circuit than the radio or TV.
- Consult the dealer or an experienced radio/TV technician for help.

Caution : FCC regulations state that any unauthorized changes or modifications to this equipment may void the user's authority to operate it.

Important Safety Instructions

Read these operating instructions carefully before using the unit. Follow all the safety instructions listed below. Keep these operating instructions handy for future reference.

- | | |
|---|---|
| <ol style="list-style-type: none"> 1) Read these instructions. 2) Keep these Instructions. 3) Heed all warnings. 4) Follow all instructions. 5) Do not use this apparatus near water. 6) Clean only with a dry cloth. 7) Do not block any ventilation openings. Install in accordance with the manufacturer's instructions. 8) Do not install near any heat sources such as radiators, heat registers, stoves, or other apparatus (including amplifiers) that produce heat. 9) Do not defeat the safety purpose of the polarized or grounding-type plug. A polarized plug has two blades with one wider than the other. A grounding type plug has two blades and a third grounding prong. The wide blade or the third prong are provided for your safety. If the provided plug does not fit into your outlet, consult an electrician for replacement of the obsolete outlet. | <ol style="list-style-type: none"> 10) Protect the power cord from being walked on or pinched particularly at plugs, convenience receptacles, and the point where they exit from the apparatus. 11) Only use attachment/accessories specified by the manufacturer. 12) Use only with the cart, stand, tripod, bracket, or table specified by the manufacturer, or sold with the apparatus. When a cart is used, use caution when moving the cart/apparatus combination to avoid injury from tip-over. 13) Unplug this apparatus during lightning storms or when unused for long periods of time. 14) Refer all servicing to qualified service personnel. Servicing is required when the apparatus has been damaged in any way, such as when the power-supply cord or plug is damaged, liquid has been spilled or objects have fallen into the apparatus, the apparatus has been exposed to rain or moisture, does not operate normally, or has been dropped. |
|---|---|



PRECAUTIONS

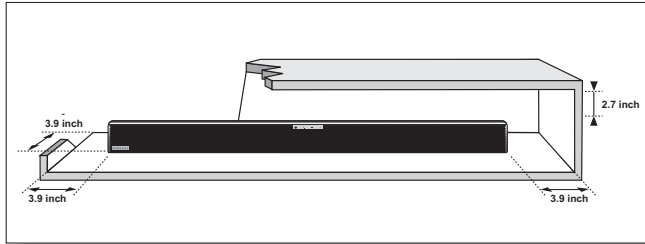

Ensure that the AC power supply in your house complies with the power requirements listed on the identification sticker located on the back of your product. Install your product horizontally, on a suitable base (furniture), with enough space around it for ventilation (3~4 inches, 7~10 cm). Make sure the ventilation slots are not covered. Do not place the unit on amplifiers or other equipment which may become hot. This unit is designed for continuous use. To fully turn off the unit, disconnect the AC plug from the wall outlet. Unplug the unit if you intend to leave it unused for a long period of time.



During thunderstorms, disconnect the AC plug from the wall outlet. Voltage peaks due to lightning could damage the unit.

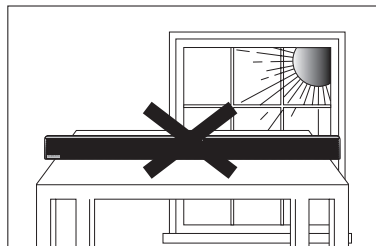

Do not expose the unit to direct sunlight or other heat sources. This could lead to overheating and cause the unit to malfunction.

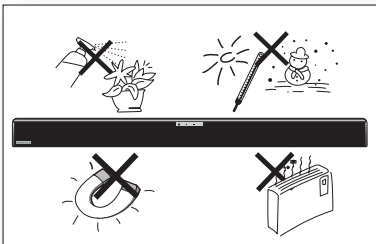

Protect the product from moisture (i.e. vases, spills), and excess heat (e.g. fire, radiators) or equipment creating strong magnetic or electric fields. Disconnect the power cable from the AC supply if the unit malfunctions. Your product is not intended for industrial use. This product is for personal use only.

Condensation may occur if your product has been stored in cold temperatures. If transporting the unit during the winter, wait approximately 2 hours until the unit has reached room temperature before using.

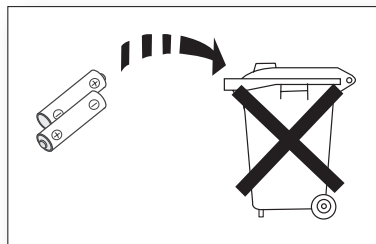

The batteries used with this product contain chemicals that are harmful to the environment. Do not dispose of batteries in the general household trash. Do not dispose of batteries in a fire. Do not short circuit, disassemble, or overheat the batteries. Danger of explosion if battery is incorrectly replaced. Replace only with the same or equivalent type.

contents



FEATURES	2	Features
	2	License
SAFETY INFORMATION	3	Safety warnings
	4	Precautions
GETTING STARTED	6	Before reading the User's Manual
	6	What's included
DESCRIPTIONS	7	Front Panel
	8	Rear Panel
REMOTE CONTROL	9	Tour of the Remote Control
CONNECTIONS	10	Installing the Wall Mount
	11	Connecting the Wireless Subwoofer
	12	Attaching the Toroidal Ferrite Core to the Power Cord of the Subwoofer
	12	Looping the power cable around the Toroidal Core
	13	Connecting an external device using HDMI cable
	14	Connecting an external device using Audio (Analog) cable or Optical (Digital) cable
FUNCTIONS	15	Input Mode
	15	Bluetooth
	17	SoundConnect
	18	USB
	19	Using the Remote Control
	22	Software Upgrade
TROUBLESHOOTING	23	Troubleshooting
APPENDIX	24	Specifications

getting started

BEFORE READING THE USER'S MANUAL

Note the following terms before reading the user manual.

Icons used in this manual

Icon	Term	Definition
	Caution	Indicates a situation where a function does not operate or settings may be canceled.
	Note	Indicates tips or instructions on the page that help you operate a function.

Safety Instructions and Troubleshooting

- 1) Be sure to familiarize yourself with the Safety Instructions before using this product. (See page 3)
- 2) If a problem occurs, check Troubleshooting. (See page 23)







Copyright

©2014 Samsung Electronics Co.,Ltd.

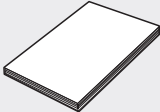
All rights reserved; no part or whole of this user's manual may be reproduced or copied without the prior written permission of Samsung Electronics Co.,Ltd.

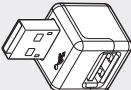
WHAT'S INCLUDED

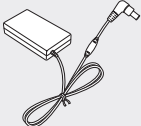
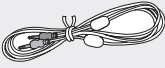
Check for the supplied accessories shown below.

			 (Holder-screw:2EA) (Screw:2EA)	
Remote Control / Batteries (AAA size) (AH59-02612B/ 4301-000116)	User Manual (AH68-02682R)	Bracket-Wall Mount (H550: AH61-03627A H551: AH61-03627B)	Screws (AH61-03342A/ 6001-001961)	USB converter (H550: AH59-02572A H551: AH59-02572B)
				(For Subwoofer power cable 1EA) 
Power Cord (3903-000598)	Adapter (BN44-00722A)	AUX Cable (BN39-01286A)	USB Cable (AH39-01178A)	Toroidal ferrite core (3301-000144)



- The appearance of the accessories may differ slightly from the illustrations above.
- Use the dedicated USB cable to connect external USB devices to the unit.

descriptions

FRONT PANEL

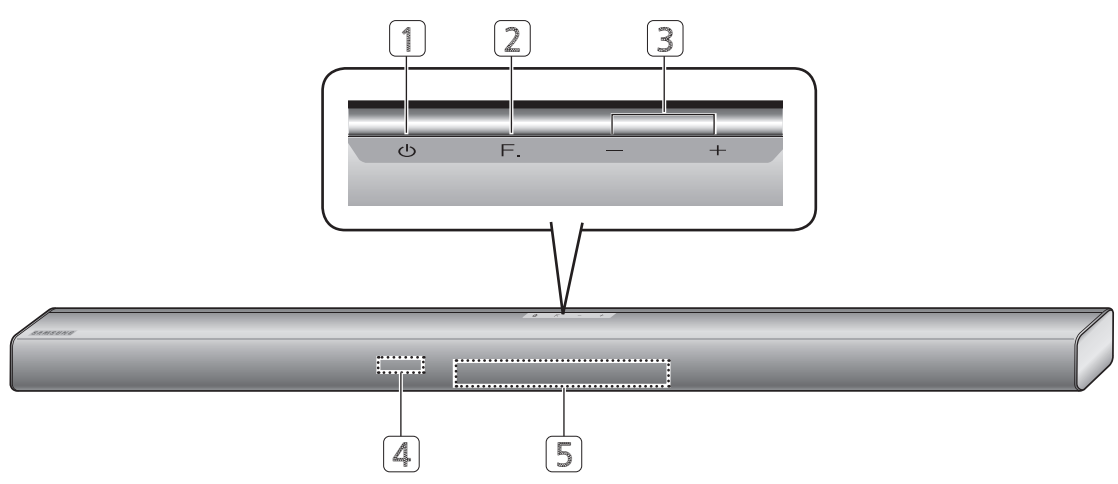

<p>1 POWER BUTTON</p>	<p>Turns the Wireless Audio - Soundbar on and off.</p>
<p>2 FUNCTION BUTTON</p>	<p>Selects the D.IN, AUX, HDMI, BT, TV, USB input. - While the Soundbar is on, pressing the (F.) button for more than 3 seconds sets the button to act as a MUTE button. To cancel the MUTE button setup, press the (F.) button for more than 3 seconds again.</p>
<p>3 VOLUME +/-</p>	<p>Controls the volume level. The numeric value of the volume level appears in the front panel display.</p>
<p>4 REMOTE CONTROL SENSOR</p>	<p>The remote control can operate Soundbars made by SAMSUNG only.</p>
<p>5 DISPLAY</p>	<p>Displays the current mode. - If there is no input from the product or remote control for 15 seconds, the display will turn off automatically. - The display will not turn off automatically in the BT READY, SEARCH, TV REQUEST, or USB PLAYING modes.</p>

- 

▪ When you turn on this unit, there will be a 4 to 5 second delay before it produces sound.
- If you want to enjoy the sound only from the Wireless Audio - Soundbar, you must turn off the TV's speakers in the Audio Setup menu of your TV. Refer to the owner's manual supplied with your TV.

descriptions

REAR PANEL

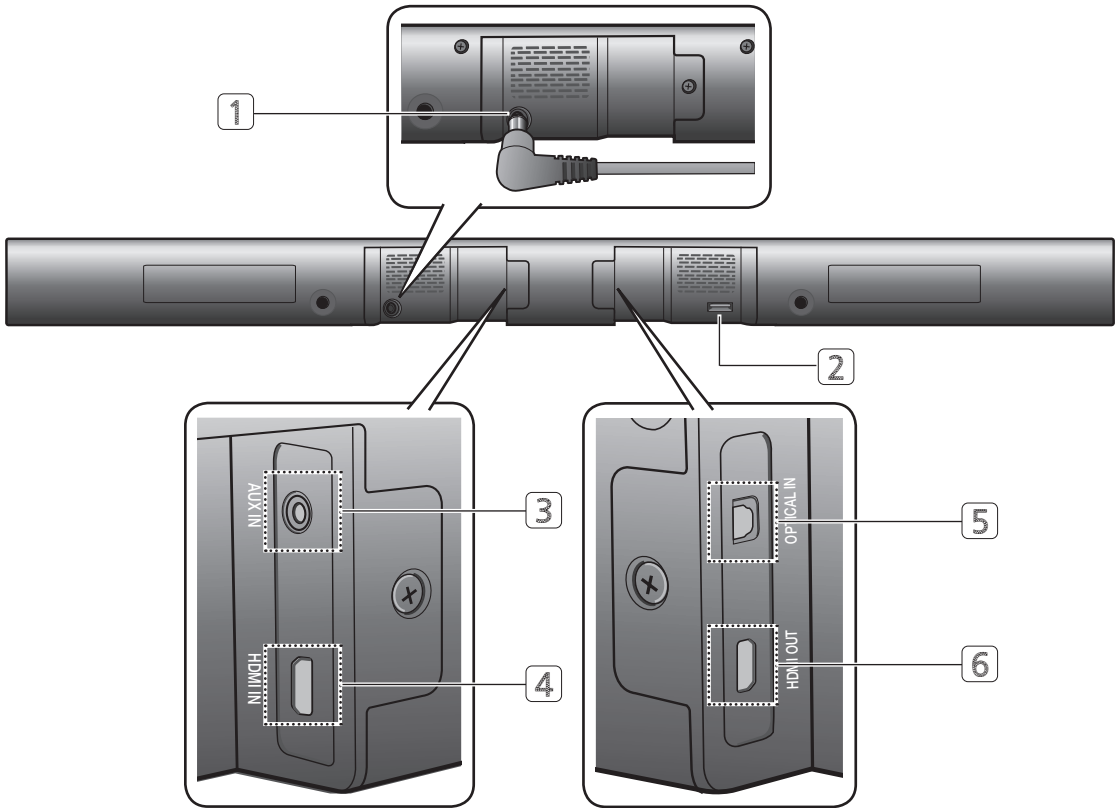

1	POWER SUPPLY IN	1. Connect the AC adaptor's power cord to the AC power supply. 2. Connect the AC power adaptor's mini-plug to Power Supply In on the unit. 3. Connect the AC adaptor's power cord to a wall outlet.
2	USB PORT	Connect USB devices such as MP3 players here to the play files on the devices. - Use the supplied USB converter if you have installed the product on a wall.
3	AUX IN	Connect to the Analog output of an external device.
4	HDMI IN JACK	Inputs digital video and audio signals simultaneously from an external source using an HDMI cable.
5	OPTICAL IN	Connect to the digital (optical) output of an external device.
6	HDMI OUT JACK	Outputs digital video and audio signals simultaneously using an HDMI cable.

- !**
- When disconnecting the power cable of the AC power adaptor from a wall outlet, pull the plug. Do not pull the cable.
 - Do not connect this unit or other components to an AC outlet until all connections between components are complete.

remote control

TOUR OF THE REMOTE CONTROL

POWER BUTTON

Turns the Wireless Audio - Soundbar on and off.

SOURCE

Press to select a connected Soundbar source.

AUTO POWER

Synchronizes the Soundbar to a connected Optical source via the Optical jack so it turns on automatically when you turn on your TV.

REPEAT

Select Repeat File, All, Random.

TV VOLUME

Adjusts the TV volume level.

TV MUTE

Mutes the sound from the TV. Press again to restore the sound to the previous volume level.

TV INFO, TV PRE-CH

Display current TV status. Moves to the previous TV channel.

CONTROL BUTTON

Play, pause, or stop playing a music file, or search forwards or backwards for a music file.

SOUND EFFECT

Selects the Sound Effect: (MUSIC, VOICE, SPORTS, CINEMA, and STANDARD)

SURROUND SOUND

This feature adds depth and spaciousness to the sound. (Surround Sound Expansion)

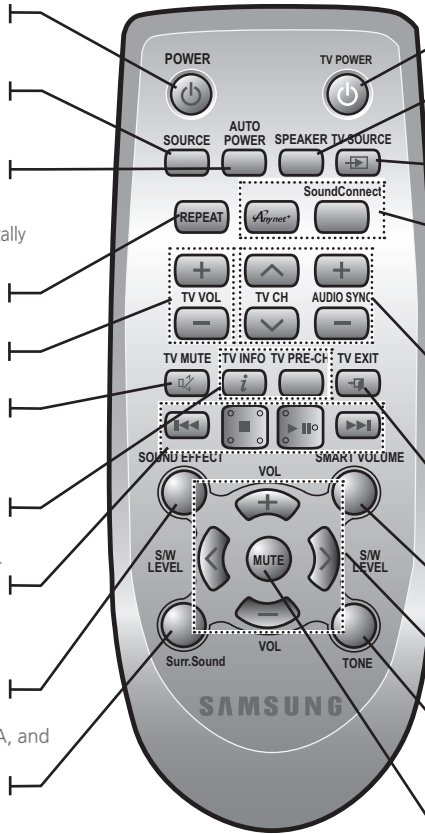

TV POWER BUTTON

Turns your Samsung TV on and off.

SPEAKER

This button allows you to choose to listen to audio from the Soundbar or your TV.

TV SOURCE

Press to select a connected TV's video source.

Anynet+, SoundConnect

Anynet+ enables you to control other Samsung Devices with your Samsung TV's remote control. Also, produces TV sound on your Soundbar via a Bluetooth connection and controls the sound.

TV CHANNEL, AUDIO SYNC

Switches between the available TV channels. Used to help sync video to audio when connected to a digital TV.

TV EXIT

Exits TV functions same as the EXIT button of the TV remote.

SMART VOLUME

Regulates and stabilizes the volume level against a drastic volume change.

VOLUME, S/W LEVEL

Adjusts the volume level of the unit. Adjusts the Subwoofer level.

TONE

Individual BASS, TREBLE adjustment. Use VOL adjustment keys.

MUTE

Mutes the sound from the unit. Press again to restore the sound to the previous volume level.



- The remote control can operate TVs made by SAMSUNG only.
- Depending on the TV you are using, you may not be able to operate your TV with this remote control. If you can't, operate the TV using the TV's remote control.
- Surround Sound Expansion Technology is Powered by Sonic Emotion.

Installing batteries in the Remote Control

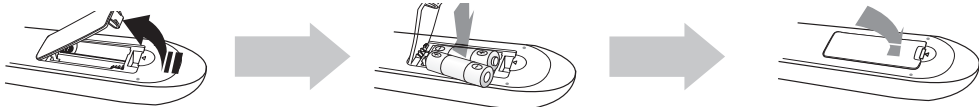

1. Lift the cover at the back of the remote control upward as shown.
2. Install two AAA size batteries. Make sure to match the "+" and "-" ends of the batteries with the diagram inside the compartment.
3. Replace the cover. Assuming typical TV usage, the batteries last for about one year.

Operational Range of the Remote Control

You can use the remote control up to 23 feet (7 meters) in a straight line from the unit. You can also operate the remote at a horizontal angle of up to 30° from the remote control sensor.

connections

INSTALLING THE WALL MOUNT

You can use the wall mount bracket to mount this unit on a wall.

Installation Precautions

- Install on a vertical wall only.
- For the installation, avoid a location with high temperature or humidity, or a wall that cannot sustain the weight of the set.
- Check the strength of the wall. If the wall is not strong enough to support the unit, reinforce the wall or install the unit on a different wall that can support the unit's weight.
- Purchase and use the fixing screws or mollys appropriate for the kind of wall you have (plaster board, iron board, wood, etc.). If possible, fix the support screws into wall studs.
- Connect cables from the unit to external devices before you install it on the wall.
- Make sure the unit is turned off and unplugged before you install it. Otherwise, it may cause an electric shock.

1. Place the wall mount bracket on a wall surface and then secure it with two screws (not supplied).
If you are hanging the unit below a TV, be sure to install the wall mount bracket so that the arrow (↑) is placed in the Centre of the TV.
Also make sure the unit is at least two inches (5 cm) below the TV.
2. Align the two HOLDER-SCREWS with the screw holes on the left and right sides of the MAIN UNIT, and then fix them to the main unit with the supplied screws.
3. Insert the USB converter into the unit before installing it on the wall.
4. Fit the unit into the corresponding slots of the wall mount bracket. For secure installation, make sure the mounting studs slide firmly down into the bottom of the slots.
5. The installation is complete.

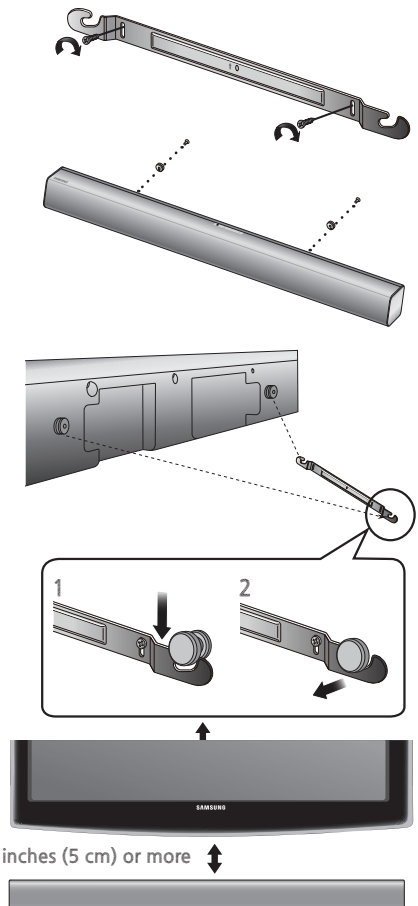

- Do not hang onto the installed unit and avoid any impact to the unit.
- Secure the unit firmly to the wall so that it does not fall off. If the unit falls off, it may cause an injury or damage the product.
- When the unit is installed on a wall, please make sure that children do not pull any of the connecting cables, as it may cause it to fall.
- For the optimal performance of a wall mount installation, install the speaker system at least 2 inches (5 cm) below the TV.
- For a better sound experience, place the subwoofer away from the wall at least 12 inches (30 cm) when installing.

CONNECTING THE WIRELESS SUBWOOFER

The Subwoofer's linking ID is preset at the factory and the main unit and subwoofer should link (connect wirelessly) automatically when the main unit is turned on. If the **LINK** indicator does not light when the main unit and subwoofer are turned on, please set the ID by following the procedure below.

1. Plug the power cords of the main unit and subwoofer into an AC wall outlet.
2. Press the **ID SET** button on the back of the subwoofer with a small, pointed object for 5 seconds.
 - The **STANDBY** indicator is turned off and the **LINK** indicator (Blue LED) blinks quickly.

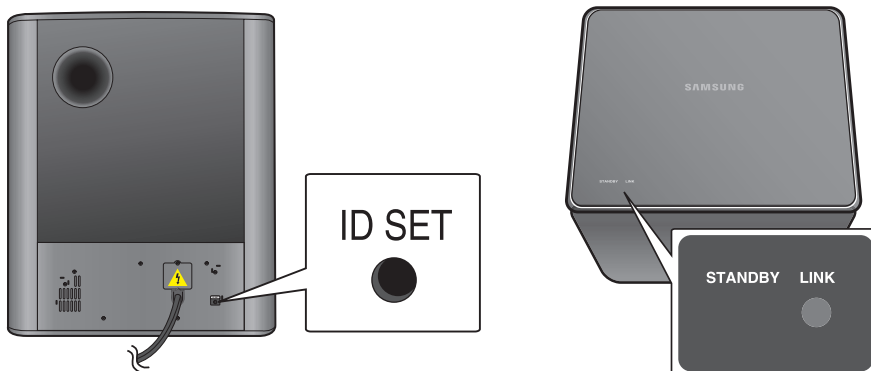

3. While the main unit is powered off (STANDBY mode), press **MUTE** on the remote control for 5 seconds.
4. The **ID SET** message appears on the main unit's OLED display.
5. To finalize the link, turn the main unit's power on while the subwoofer's **LINK** LED blinks.
 - The main unit and the subwoofer are now linked (connected).
 - The **LINK** indicator (blue LED) on the subwoofer is turned on.
 - You can enjoy better sound from the wireless subwoofer by selecting a sound effect. (See page 20)

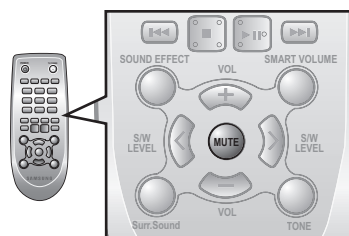

- Before moving or installing the product, be sure to turn off the power and disconnect the power cord.
- If the main unit is powered off, the wireless subwoofer will be in the standby mode and the **STANDBY** LED on the upper side will come on after the **LINK** indicator (Blue LED) blinks for 30 seconds.
- If you use a device that uses the same frequency (2.4GHz) near the system, interference may cause some sound interruption.
- The maximum wireless signal transmission distance between the main unit and subwoofer is about 33 ft., but may vary depending on your operating environment. If a steel-concrete or metallic wall is between the main unit and the wireless subwoofer, the system may not operate at all, because the wireless signal cannot penetrate metal.
- If the main unit doesn't make a wireless connection, follow steps 1-5 above to retry the connection between the main unit and wireless subwoofer.



- The wireless receiving antenna is built into the wireless subwoofer. Keep the unit away from water and moisture.
- For optimal listening performance, make sure that the area around the wireless subwoofer location is clear of any obstructions.

connections

ATTACHING THE TOROIDAL FERRITE CORE TO THE POWER CORD OF THE SUBWOOFER

Attaching the Toroidal ferrite core to the power cord of the subwoofer helps prevent RF interference from radio signals.

1. Pull the fixing tab of the Toroidal ferrite core to open it.
2. Make two loops around the core with the power cable of the subwoofer.
3. Attach the Toroidal ferrite core to the Subwoofer power cord as the figure shows, and then press it until it clicks.

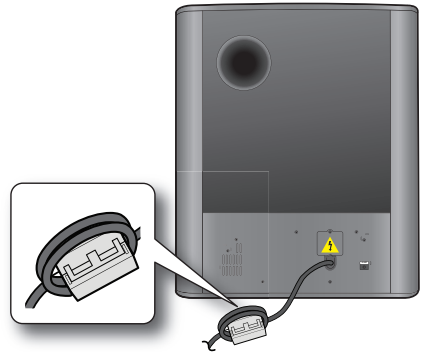

LOOPING THE POWER CABLE AROUND THE TOROIDAL CORE

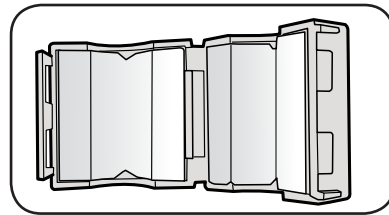
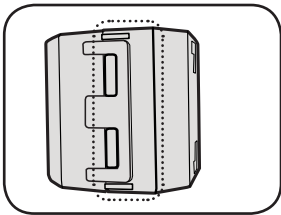

Lift up to release the lock and open the core.

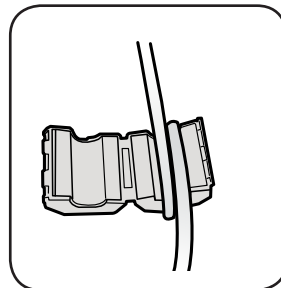
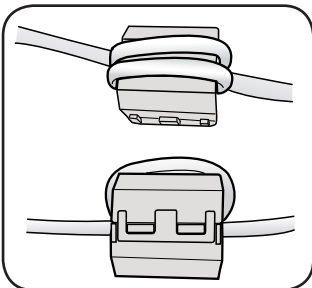

Close the lock.

Make two loops around the core with the power cable.
(Start winding 2 to 4 inches [5-10 cm] away from the core).

CONNECTING AN EXTERNAL DEVICE USING HDMI CABLE

HDMI is the standard digital interface for connecting to such devices as a TVs, projectors, DVD players, Blu-ray players, set top boxes, and more.

HDMI removes any loss of signal from analog conversion, enabling you to enjoy video and audio sound quality as it was originally created in the digital source.

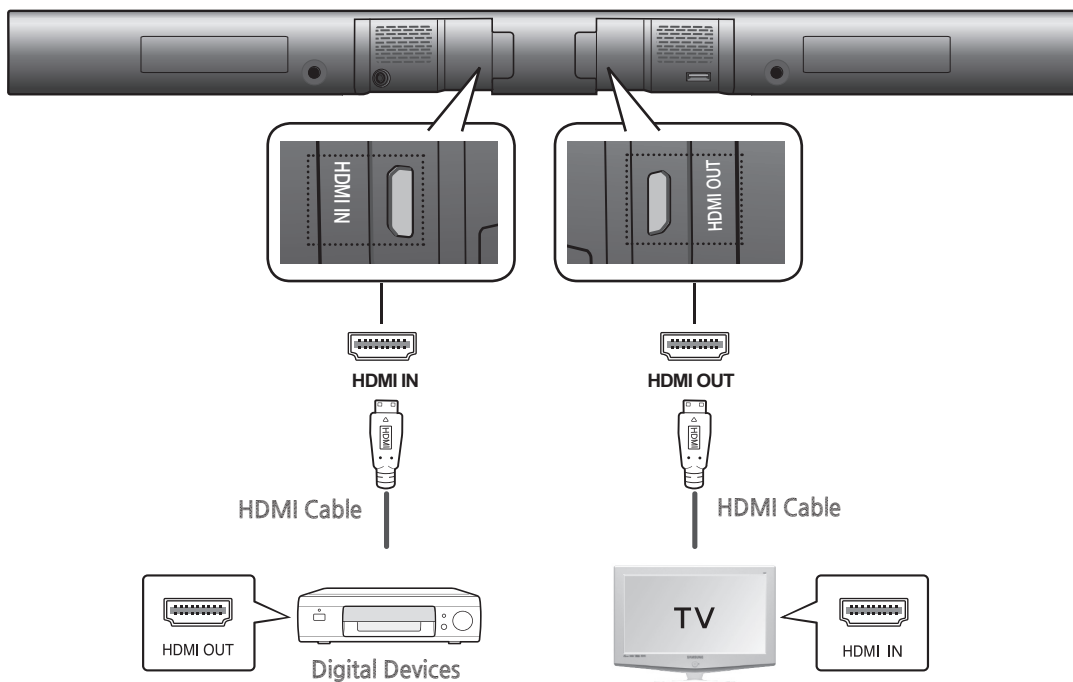

HDMI IN

Connect an HDMI cable (not supplied) from the HDMI IN jack on the back of the product to the HDMI OUT jack on your digital device.

and,

HDMI OUT (HDMI)

- Connect an HDMI cable from the HDMI OUT jack on the back of the product to the HDMI IN jack on your TV.



- HDMI is an interface that transmits digital video and audio data with just a single connector.

HDMI OUT (ARC)

- The ARC function allows digital audio to output via the HDMI OUT (ARC) port. It can be enabled only when the Soundbar is connected to a TV that supports the ARC function.
- Anynet+ must be turned on.



- This function is not available if the HDMI cable does not support ARC.

connections

CONNECTING AN EXTERNAL DEVICE USING AUDIO (ANALOG) CABLE OR OPTICAL (DIGITAL) CABLE

This unit comes equipped with one optical in digital jack and one audio analog in jack, giving you two ways to connect it to a TV.

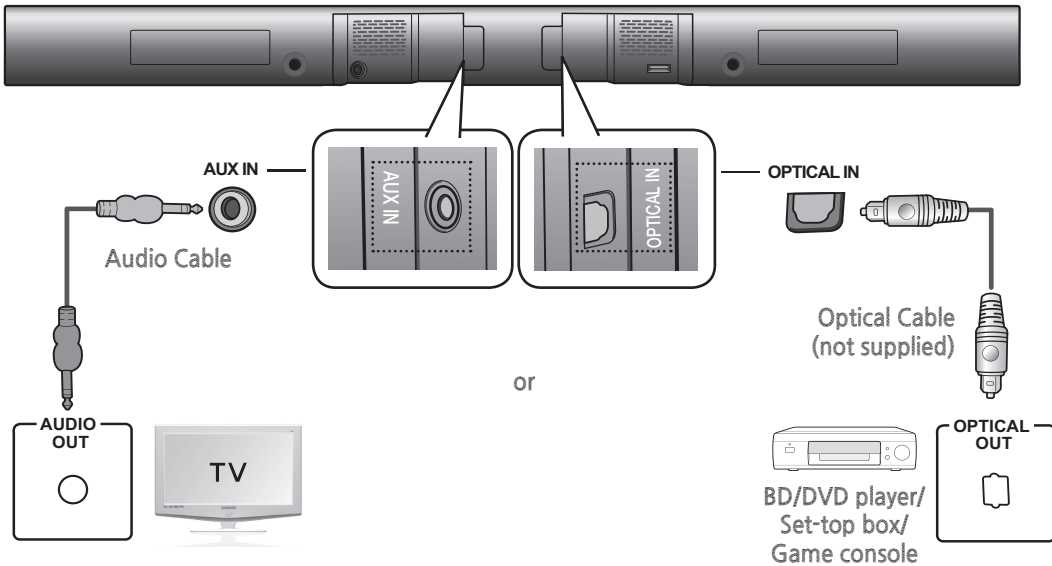

AUX IN

Connect AUX IN (Audio) on the main unit to the AUDIO OUT of the TV or Source Device. Be sure to match connector colors.

or,

OPTICAL IN

Connect the Digital Input on the main unit to the OPTICAL OUT of the TV or Source Device.



- Do not connect the power cord of this product or your TV to the wall outlet until all connections between components are complete.
- Before moving or installing this product, be sure to turn off the power and disconnect the power cord.

functions

INPUT MODE

You can select D.IN, AUX, HDMI, BT, TV input, or USB.

Press an appropriate button on the remote control to select a desired mode, or press **(F.)** to select : D.IN, AUX, HDMI, BT, TV, or USB mode.

Input mode	Display
Optical Digital input	D.IN
AUX input	AUX
HDMI input	HDMI
BLUETOOTH mode	BT
TV mode	TV
USB mode	USB

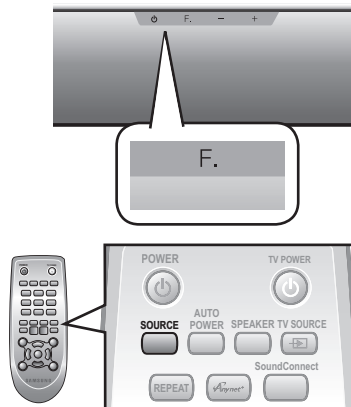

The unit turns off automatically in the following situations:

- BT/TV MODE
 - If the connection has been off for about 25 minutes.
- USB/HDMI/ARC/D.IN MODE
 - If there is no audio signal for about 25 minutes.
- AUX Mode
 - When the AUX cable is connected, if no key is pressed on the remote or unit panel for about 8 hours.
 - If the AUX cable is disconnected for about 25 minutes.



- The ARC function is activated in D.IN mode if the unit is connected to an ARC supporting TV.
- To turn off the ARC function, turn Anynet off.
- Use the provided cable if a USB flash memory device cannot be connected directly to the unit.

BLUETOOTH

You can use a Bluetooth device to enjoy music with high quality stereo sound, all without wires!

What is Bluetooth?

Bluetooth is a technology that enables Bluetooth-compliant devices to interconnect easily with each other using a short, wireless connection.

- A Bluetooth device may cause noise or malfunction, depending on usage, when:
 - A part of your body is in contact with the receiving/transmitting system of the Bluetooth device or the Soundbar.
 - It is subject to electrical variation from obstructions caused by a wall, corner, or office partition.
 - It is exposed to electrical interference from same frequency-band devices including medical equipment, microwave ovens, and wireless LANs.
- Pair the Soundbar with the Bluetooth device while they are close together.
- The further the distance is between the Soundbar and Bluetooth device, the worse the quality is. If the distance exceeds the Bluetooth operational range, the connection is lost.
- In poor reception-sensitivity areas, the Bluetooth connection may not work properly.
- The Bluetooth connection only works when it is close to the set. The connection will be automatically cut off if the Bluetooth device is out of range. Even within range, the sound quality may be degraded by obstacles such as walls or doors.
- This wireless device may cause electric interference during its operation.

functions

To connect the Soundbar to a Bluetooth device

Check if the Bluetooth device supports the Bluetooth compliant stereo headset function.

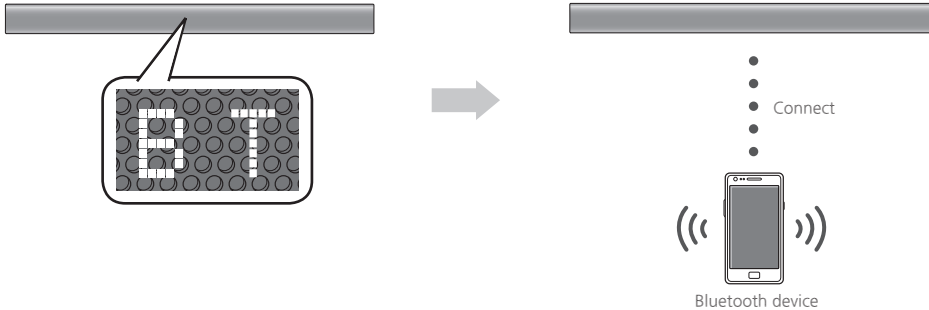

1. Press the **SOURCE** button on the remote control of the Soundbar to display the **BT** message.
 - You will see **BT READY** on the front display of the Soundbar.
2. On the Bluetooth device you want to connect, open the Bluetooth menu. (Refer to the Bluetooth device's user manual.)
3. Select the Stereo headset menu on the Bluetooth device.
 - You will see a list of scanned devices.
4. Select "[Samsung] Soundbar" from the list.
 - When the Soundbar is connected to the Bluetooth device, it will display **Device name** → **BT** on the front display.
 - If the Bluetooth device has failed to pair with the Soundbar, delete the previous "[Samsung] Soundbar" found by the Bluetooth device and have it search for the Soundbar again.
 - If the Soundbar is in another mode (except TV mode), you can shift it to Bluetooth mode using your smart device.
5. Play music on the connected device.
 - You can listen to the music playing on the connected Bluetooth device over the Wireless Audio - Soundbar system.
 - In BT mode, Repeat functions are not available. For some Bluetooth device, Play/Stop/Next/Prev function are not available.



- You may be required to enter a PIN code (password) when connecting the Bluetooth device to the Soundbar. If the PIN code input window appears, enter <0000>.
- The Soundbar supports SBC data (44.1kHz, 48kHz).
- The AVRCP feature is supported.
- Connect only to a Bluetooth device that supports the A2DP (AV) function.
- You cannot connect to a Bluetooth device that supports only the HF (Hands Free) function.
- Only one Bluetooth device can be paired at a time.
- Once you have turned off the Soundbar and the pairing is disconnected, the pairing will not be restored automatically. To reconnect, you must pair the device again.
- The Soundbar may not run the Bluetooth Search or Connection functions properly in the following cases:
 - If there is a strong electrical field around the Soundbar.
 - If several Bluetooth devices are simultaneously paired with the Soundbar.
 - If the Bluetooth device is turned off, not in place, or malfunctions.
 - Note that such devices as microwave ovens, wireless LAN adaptors, fluorescent lights, and gas stoves use the same frequency range as the Bluetooth device, which can cause electric interference.
- Once paired the device, on ARC/DIN/USB/HDMI/AUX mode, select "[Samsung] Soundbar" from the list will automatically change to BT mode.

To disconnect the Bluetooth device from the Soundbar

You can disconnect the Bluetooth device from the Soundbar.
For instructions, see the Bluetooth device's user manual.

- The Soundbar will be disconnected.
- When the Soundbar is disconnected from the Bluetooth device, the Soundbar will display **BT DISCONNECTED** on the front display.

To disconnect the Soundbar from the Bluetooth device

Press the **(F.)** button on the front panel of the Soundbar to switch from **BT** to another mode, or turn off the Soundbar.

- The connected Bluetooth device will wait a certain amount of time for a response from the Soundbar before terminating the connection. (Disconnection time may differ, depending on the Bluetooth device)
- The currently connected device will be disconnected.



- In Bluetooth connection mode, the Bluetooth connection will be lost if the distance between the Soundbar and the Bluetooth device exceeds 16.25 ft. (5m).
- If the Bluetooth device comes back into the effective range after disconnecting, you can restart the Soundbar to restore the pairing with the Bluetooth device.

Using the Bluetooth Power on

When the Soundbar is turned off, connect your smart device to the Soundbar via a Bluetooth connection to turn it on.

1. Pair your smart device with the Soundbar via Bluetooth. (For information on Bluetooth connections, refer to your smart device's manual.)
2. Turn the Soundbar off, and then press and hold the **(F.)** button on the Soundbar's front panel until the Soundbar displays Bluetooth Power On.
3. Now, whenever the Soundbar is off, and you initiate a Bluetooth connection with your smart device, the Soundbar will turn itself on automatically in Bluetooth mode.
 - Select the desired music to play from your smart device.

SOUNDCONNECT

SoundConnect lets you play TV audio from a Bluetooth compliant SAMSUNG TV on your Wireless Audio - Soundbar via a Bluetooth connection.

- To produce TV sound on your Soundbar via a Bluetooth connection, you need to pair your Soundbar to a Bluetooth compliant TV. Once the pairing is established, the pairing information is recorded and kept. No further Bluetooth connection messages will appear.
- Bring the Soundbar and the TV close together before pairing.
- The unit will play the TV's audio when it is set to SoundConnect mode and paired with the TV.
- If you change to another mode, other than TV mode, or turn off the Soundbar, you will hear audio from the TV's speakers again.

Connecting the Soundbar to a Bluetooth Compatible Samsung TV

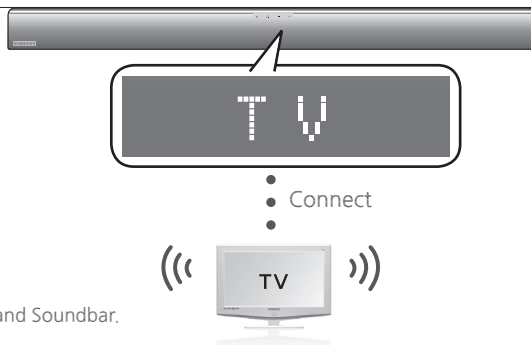

1. Turn on the Samsung TV and Soundbar.
2. Set Add New Device in the TV's SoundConnect Setting menu to On.
 - Depending on your TV, the TV's Setting menu may have a SoundShare menu item instead of a SoundConnect menu item.
3. Press the **(F.)** button to change the mode of the Soundbar to **TV**. A message asking whether to proceed with Bluetooth pairing and "[Samsung] Soundbar" appears on the TV screen.
4. Select **<Yes>** on the TV screen. The TV pairs with the Soundbar.

functions

- Once the pairing is established, when you change the Soundbar to the TV mode from other input modes, it will automatically connect to the TV.
- The Soundbar will play the TV's audio when it is connected to the TV.
- Changing the Soundbar from TV mode to any other mode will cancel the SoundConnect connection.
- If you want to cancel the existing pairing of the Soundbar to a TV and pair your Soundbar to a different TV:
 - Press the **PLAY/PAUSE** button on the Soundbar for 5 seconds in the TV input mode to cancel the existing pairing. You can now pair it to a different TV.
- In the SoundConnect mode, you can control the volume and mute using either the TV remote or the Soundbar remote.



- TV SoundConnect operation range
 - recommended pairing range: within 20 inches (within 50cm)
 - recommended operation range: within 16.25 ft. (5m)
- If the distance between the Soundbar and Samsung TV is over 16.25 ft. (5m), the connection or the sound can be cut off. If this occurs, connect to the Samsung TV again within the operational range.
- Make sure the Samsung TV's SoundConnect mode is on before you use this function.
- The **PLAY, NEXT, PREV, STOP** buttons will not work in the SoundConnect mode.
- Bluetooth Power On function
 - The Soundbar will be powered on automatically when you turn the TV on if you connected the TV and Soundbar with the SoundConnect function.
 - You can toggle this function On/Off by pressing and holding the SOURCE button on the Soundbar remote for more than 5 seconds when the Soundbar is powered off. If set to Off, the product turns off automatically when the TV turns off, but it does not turn on automatically.
 - This feature is supported by TVs released beginning in 2013.
- The SoundConnect feature is supported by select models released from 2012 on. Check whether your TV supports SoundConnect (SoundShare) before you begin. (For more information, refer to the user's guide of your TV.)

USB

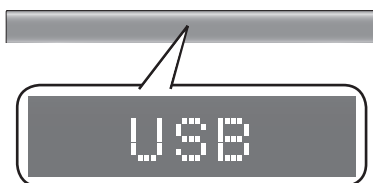

1. Connect a USB device to the USB port on the side of the unit.
2. Press the **(F.)** button on the front panel of the Soundbar repeatedly until **USB** appears.
3. **USB** appears on the display screen and then disappears.
 - The Wireless Audio - Soundbar connection is complete.

Before you connect a USB device

Be aware of the following:

- If the file name of a folder on a USB device exceeds 10 characters, it is not shown on the Soundbar's display.
- This product may not be compatible with certain types of USB storage media.
- The Soundbar supports the FAT16 and FAT32 file systems.
 - The NTFS file system is not supported.

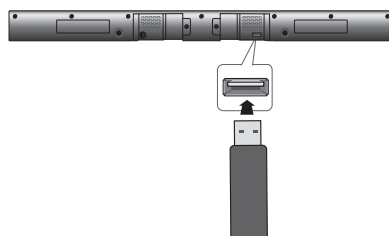

- Connect USB devices directly to the USB port of the product. Otherwise, you may encounter a USB compatibility problem.
- Do not connect multiple storage devices to the product via a multi-card reader. It may not operate properly.
- Digital camera PTP protocols are not supported.
- Do not remove the USB device while it is being read.
- DRM-protected music files (MP3, WMA) from a commercial web site will not be played.
- External HDDs are not supported.
- Mobile phone devices are not supported.
- File Format Type Compatibility list:

Format	Codec
*.mp3	MPEG 1 Layer2
	MPEG 1 Layer3
	MPEG 2 Layer3
*.wma	Wave_Format_MSAudio1
	Wave_Format_MSAudio2
*.aac	AAC
	AAC-LC
	HE-AAC
*.wav	-
*.Ogg	OGG 1.1.0
*.Flac	FLAC 1.1.0, FLAC 1.2.1

※ Supporting Sampling Rate above 16KHz

USING THE REMOTE CONTROL

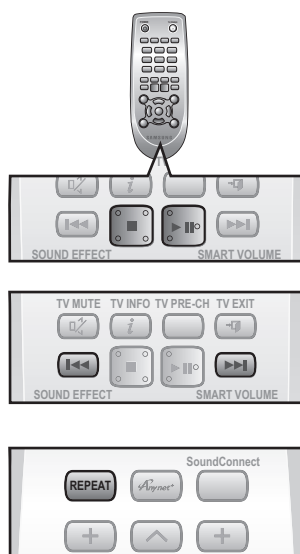

Play/Pause/Stop

During playback, press the ►||■ button.

- Press the ►|| button to pause the file.
Press the ►|| button again to play the file.
- To stop playback, press the Stop (■) button during playback.

Skip Forward/Back

During playback, press the ◀◀▶▶ button.

- When there is more than one file on a USB device and you press the ▶▶ button, the next file is selected.
- When there is more than one file on a USB device and you press the ◀◀ button, the previous file is selected.

Using the REPEAT function

Repeat playback allows you to repeatedly play a file, repeat all files, randomly play files, or turn Repeat off.

Press the REPEAT button.

- **REPEAT OFF** : Cancels Repeat Playback.
- **REPEAT FILE** : Plays the same file repeatedly.
- **REPEAT ALL** : Plays all tracks in order repeatedly.
- **REPEAT RANDOM** : Plays tracks in random order. (A track that has already been played may be played again.)



- You can set the REPEAT function while playing back music from a USB drive.

functions



Muting the sound

This is useful when answering a doorbell or telephone call.

1. To mute the sound of this unit, press the **MUTE** button on the remote control.
2. To mute the TV, press the **TV MUTE** (🔇) button on the remote control.
3. Press **MUTE / TV MUTE** (🔇) on the remote control again (or press **VOLUME +/-**) to restore the sound.

Using the SURROUND SOUND function

The Surround Sound feature adds depth and spaciousness to the sound.

Press **Surr. Sound** on the remote control.

- Each time the button is pressed, the selection changes as follows :
SURROUND SOUND AUTO ➔ SURROUND SOUND ON ➔ SURROUND SOUND OFF



- When you turn on Surround Sound, the Smart Volume and Sound Effect functions automatically change to OFF.

Using the SMART VOLUME function

This will regulate and stabilize the volume level against a drastic volume change caused by a channel change or scene transition.

Press **SMART VOLUME** on the remote control.

- Each time the button is pressed, the selection changes as follows :
SMART VOLUME ON ➔ SMART VOLUME OFF



- When you turn on Smart Volume, the Surround Sound and Sound Effect function automatically change to OFF.

Using the SOUND EFFECT function

You can select from 5 different sound modes - MUSIC, VOICE, SPORTS, CINEMA, and STANDARD - depending on the type of sources you want to enjoy.

Press **SOUND EFFECT** on the remote control.

- Select the **STANDARD** mode if you want to enjoy the original sound.



- We recommend that you select a Sound Effect based on the source material and your personal taste.
- When you choose a Sound Effect mode (except STANDARD), the Surround Sound and Smart Volume functions are automatically set to OFF.

Using the S/W LEVEL function

You can control the base (subwoofer) volume with the S/W Level button on the remote control.

1. Press the **S/W LEVEL** button on the remote control.
2. "SW 0" appears on the display.
3. Press **< or >** button on the **LEVEL** key if you want to increase or decrease the subwoofer volume. You can set it from SW -6 to SW +6.

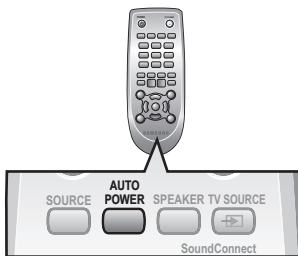

Using the AUTO POWER LINK function

If you connect the main unit to a TV with a digital optical cable, set the Auto Power function ON to have the Soundbar turn on automatically when you turn the TV on.

Press the **AUTO POWER** button on the Soundbar remote to turn the AUTO POWER function on and off.

- The Auto power function turns on and off each time you press **AUTO POWER**.

AUTO POWER LINK	Display
ON	POWER LINK ON
OFF	POWER LINK OFF



- This function is available only when Anynet+ (HDMI-CEC) is turned off.

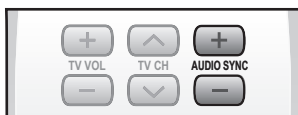

Using the AUDIO SYNC function

Video may appear out of synch with the audio if the Soundbar is connected to a digital TV. If this occurs, adjust the audio delay time to match the video.

Press **AUDIO SYNC +/-** on the remote control of this unit.

- You can use the +, - buttons to set the audio delay time between 0 ms and 300 ms.



- In USB mode, TV mode, or BT mode, the Audio Sync function may not work.

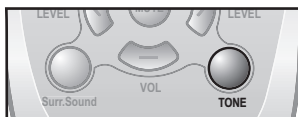

Using the TONE function

Press **TONE** on the Soundbar remote.

- Each time the button is pressed, the selection changes as follows : TREBLE → BASS. Press the **VOL +** or **VOL -** button to increase or decrease the Treble or Bass volume. You can set the Tone setting for each from -3 to +3.



SPEAKER button

If the TV and Soundbar are connected via HDMI, this button lets you select between listening to audio through your TV or through the Soundbar.

Press **SPEAKER** on the remote control of this unit.

AUDIO MODE	SPEAKER	Scroll Display	Display
HDMI IN	TV	TV SPEAKER	TV SPK
	Soundbar	AVR SPEAKER	HDMI
ARC	TV	TV SPEAKER	S MUTE
	Soundbar	AVR SPEAKER	TV ARC

functions

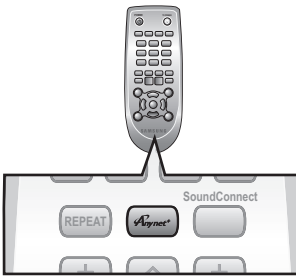

Using the Anynet+(HDMI-CEC) function

Anynet+ lets you control other Samsung Devices with your Samsung TV's remote control.

The Anynet+ function turns on and off each time you press **Anynet+**.

1. Connect the product to a Samsung TV with an HDMI cable. (See page 13)
2. Set the Anynet+ function on your TV and the Soundbar to ON. (See the TV instruction manual for more information.)



- Depending on your TV, certain HDMI output resolutions may not work.
- Please refer to the user's manual of your TV and check for the **Anynet+** logo (If your TV has an **Anynet+** logo, then it supports the Anynet+ function.)



Using the TV functions (with Samsung TVs only)

- Press **TV SOURCE** on the remote control to change the TV's input source.
- Press **TV INFO** on the remote control to display the TV channel information.
- Press **TV CH** on the remote control to select the TV channel.
- Press **TV VOL** on the remote control to increase or decrease the volume level.
- Use **TV PRE-CH** button to move to the previous TV channel in TV mode.
- To exit the TV menu, use the **TV EXIT** button. (It functions the same as the EXIT button of the TV remote control.)



- When you press the **SoundConnect** button, the TV's sound is transmitted through the Soundbar system via a Bluetooth connection. The Soundbar also controls the sound volume, sound quality, etc.
- The remote control can operate TVs made by SAMSUNG only.

SOFTWARE UPGRADE

Samsung may offer upgrades for the Wireless Audio - Soundbar's system firmware in the future.

If an upgrade is offered, you can upgrade the firmware by connecting a USB drive with the firmware upgrade stored on it to the USB port on your Soundbar.

Note that if there are multiple upgrade files, you must load them onto the USB drive singly and use them to upgrade the firmware one at a time.

Please visit Samsung.com or contact the Samsung call center to receive more information about downloading upgrade files.

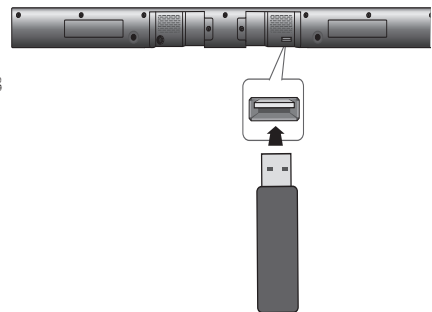

- Insert a USB drive containing the firmware upgrade into the USB port on the main unit.
- Do not disconnect the power or remove the USB drive while upgrades are being applied. The main unit will turn off automatically after completing the firmware upgrade. When software is upgraded, settings you have made will return to their default (factory) settings. We recommend you write down your settings so that you can easily reset them after the upgrade.
- Once upgrading the product software is completed, turn off the product and then press and hold (■) button for a while to reset the product.
- If the firmware fails to upgrade, we recommend formatting the USB device in FAT16 and trying again.
- For upgrading purposes, do not format the USB drive in NTFS format because it is not a supported file system.
- Depending on the manufacturer, some USB devices may not be supported.

troubleshooting

Before requesting service, please review the following.

Symptom	Check	Remedy
The unit will not turn on.	<ul style="list-style-type: none"> Is the power cord plugged into the outlet? 	<ul style="list-style-type: none"> Connect the power plug to the outlet.
A function does not work when the button is pressed.	<ul style="list-style-type: none"> Is there static electricity in the air? 	<ul style="list-style-type: none"> Disconnect the power plug and connect it again.
Sound is not produced.	<ul style="list-style-type: none"> Is the unit properly connected to your TV? Is the Mute function on? Is the volume set to minimum? 	<ul style="list-style-type: none"> Connect it correctly. Press the Mute button to cancel the Mute function. Adjust the volume.
The Picture does not appear on a TV when a function is selected.	<ul style="list-style-type: none"> Is the TV connected properly? 	<ul style="list-style-type: none"> Connect it correctly.
The remote control does not work.	<ul style="list-style-type: none"> Are the batteries drained? Is the distance between remote control and main unit too far? 	<ul style="list-style-type: none"> Replace with new batteries. Move closer to the unit.
The sound from the left/right channels are reversed.	<ul style="list-style-type: none"> Are the left/right audio output cables from the TV connected properly? 	<ul style="list-style-type: none"> Check the left/right channel and connect it/them correctly.
The SoundConnect (TV pairing) failed.	<ul style="list-style-type: none"> Does your TV support SoundConnect? Is your TV firmware the latest version? Does an error occur when connecting? Reset the TV MODE and connect again. 	<ul style="list-style-type: none"> SoundConnect is supported by some Samsung TVs released from 2012 on. Check your TV to see if it supports SoundConnect. Update your TV with the latest firmware. Contact the Samsung call center. Press the ► button for 5 seconds to reset the product.

appendix

SPECIFICATIONS

Model name	HW-H550/ HW-H551		
GENERAL	Power supply	Main unit	DC 24V
		Subwoofer	AC 120V~60Hz
	Standby power consumption		0.45W
	Power consumption	Main unit	30W
		Subwoofer	20W
	USB		5V/0.5A
	Weight	Main unit	4.85 lbs
		Subwoofer	16.52 lbs
	Dimensions (W x H x D)	Main unit	37.13 x 2.17 x 2.36 inches
		Subwoofer	11.42 x 14.57 x 11.42 inches
	Operating temperature range		+41°F to +95°F
Operating humidity range		10 % to 75 %	
AMPLIFIER	Rated output power	Main unit	80W/CH, 30HM, THD = 10%, 1kHz
		Subwoofer	160W, 40HM, THD = 10%, 100Hz
	S/N ratio (analog input)		65 dB
	Separation(1kHz)		65 dB

* S/N ratio, distortion, separation and usable sensitivity are based on measurement using AES (Audio Engineering Society) guidelines.

*: Nominal specification

- Samsung Electronics Co., Ltd reserves the right to change the specifications without notice.

- Weight and dimensions are approximate.



As an ENERGY STAR Partner, Samsung has determined that this product or product models meets the ENERGY STAR guidelines for energy efficiency.

WARRANTY

LIMITED WARRANTY TO ORIGINAL PURCHASER

This SAMSUNG brand product, as supplied and distributed by Samsung Electronics America, Inc. (SAMSUNG) and delivered new, in the original carton to the original consumer purchaser, is warranted by SAMSUNG against manufacturing defects in materials and workmanship for a limited warranty period of:

One (1) Year Parts and Labor*

(*90 Days Parts and Labor for Commercial Use)

This limited warranty begins on the original date of purchase, and is valid only on products purchased and used in the United States. To receive warranty service, the purchaser must contact SAMSUNG for problem determination and service procedures. Warranty service can only be performed by a SAMSUNG authorized service center. The original dated bill of sale must be presented upon request as proof of purchase to SAMSUNG or SAMSUNG's authorized service center. Transportation of the product to and from the service center is the responsibility of the purchaser.

SAMSUNG will repair or replace this product, at our option and at no charge as stipulated herein, with new or reconditioned parts or products if found to be defective during the limited warranty period specified above. All replaced parts and products become the property of SAMSUNG and must be returned to SAMSUNG. Replacement parts and products assume the remaining original warranty, or ninety (90) days, whichever is longer.

SAMSUNG's obligations with respect to software products distributed by SAMSUNG under the SAMSUNG brand name are set forth in the applicable end user license agreement. Non-SAMSUNG hardware and software products, if provided, are on an "AS IS" basis. Non-SAMSUNG manufacturers, suppliers, publishers, and service providers may provide their own warranties.

This limited warranty covers manufacturing defects in materials and workmanship encountered in normal, and except to the extent otherwise expressly provided for in this statement, noncommercial use of this product, and shall not apply to the following, including, but not limited to: damage which occurs in shipment; delivery and installation; applications and uses for which this product was not intended; altered product or serial numbers; cosmetic damage or exterior finish; accidents, abuse, neglect, fire, water, lightning or other acts of nature; use of products, equipment, systems, utilities, services, parts, supplies, accessories, applications, installations, repairs, external wiring or connectors not supplied and authorized by SAMSUNG, or which damage this product or result in service problems; incorrect electrical line voltage, fluctuations and surges; customer adjustments and failure to follow operating instructions, cleaning, maintenance and environmental instructions that are covered and prescribed in the instruction book; product removal or reinstallation; reception problems and distortion related to noise, echo, interference or other signal transmission and delivery problems. SAMSUNG does not warrant uninterrupted or error-free operation of the product.

THERE ARE NO EXPRESS WARRANTIES OTHER THAN THOSE LISTED AND DESCRIBED ABOVE, AND NO WARRANTIES WHETHER EXPRESS OR IMPLIED, INCLUDING, BUT NOT LIMITED TO, ANY IMPLIED WARRANTIES OF MERCHANTABILITY OR FITNESS FOR A PARTICULAR PURPOSE, SHALL APPLY AFTER THE EXPRESS WARRANTY PERIODS STATED ABOVE, AND NO OTHER EXPRESS WARRANTY OR GUARANTY GIVEN BY ANY PERSON, FIRM OR CORPORATION WITH RESPECT TO THIS PRODUCT SHALL BE BINDING ON SAMSUNG. SAMSUNG SHALL NOT BE LIABLE FOR LOSS OF REVENUE OR PROFITS, FAILURE TO REALIZE SAVINGS OR OTHER BENEFITS, OR ANY OTHER SPECIAL, INCIDENTAL OR CONSEQUENTIAL DAMAGES CAUSED BY THE USE, MISUSE OR INABILITY TO USE THIS PRODUCT, REGARDLESS OF THE LEGAL THEORY ON WHICH THE CLAIM IS BASED, AND EVEN IF SAMSUNG HAS BEEN ADVISED OF THE POSSIBILITY OF SUCH DAMAGES. NOR SHALL RECOVERY OF ANY KIND AGAINST SAMSUNG BE GREATER IN AMOUNT THAN THE PURCHASE PRICE OF THE PRODUCT SOLD BY SAMSUNG AND CAUSING THE ALLEGED DAMAGE. WITHOUT LIMITING THE FOREGOING, PURCHASER ASSUMES ALL RISK AND LIABILITY FOR LOSS, DAMAGE OR INJURY TO PURCHASER AND PURCHASER'S PROPERTY AND TO OTHERS AND THEIR PROPERTY ARISING OUT OF THE USE, MISUSE OR INABILITY TO USE THIS PRODUCT SOLD BY SAMSUNG NOT CAUSED DIRECTLY BY THE NEGLIGENCE OF SAMSUNG. THIS LIMITED WARRANTY SHALL NOT EXTEND TO ANYONE OTHER THAN THE ORIGINAL PURCHASER OF THIS PRODUCT, IS NONTRANSFERABLE AND STATES YOUR EXCLUSIVE REMEDY.

Some states do not allow limitations on how long an implied warranty lasts, or the exclusion or limitation of incidental or consequential damages, so the above limitations or exclusions may not apply to you. This warranty gives you specific legal rights, and you may also have other rights which vary from state to state.

To obtain warranty hardware service, please contact SAMSUNG customer care center.



QUESTIONS OR COMMENTS?

COUNTRY	CALL	OR VISIT US ONLINE AT	WRITE
IN THE US	1-800-SAMSUNG (726-7864)	www.samsung.com/us	Samsung Electronics America, Inc. 85 Challenger Road Ridgefield Park, NJ 07660