

connex.

MODEL:SBS-32Z4

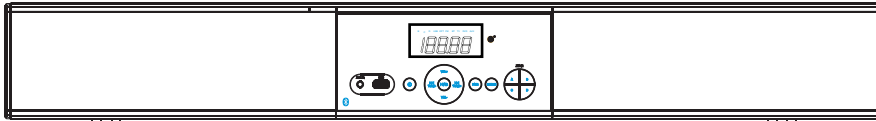

--INSTALLATION AND OPERATION MANUAL--
PLEASE READ INSTRUCTIONS CAREFULLY
AND KEEP FOR FUTURE REFERENCE

TABLE OF CONTENTS

INTRODUCTION.....	1
FEATURES.....	1
PACKING LIST.....	1
IMPORTANT SAFETY INSTRUCTIONS.....	2-3
PLACING AND MOUNTING.....	4
GENERAL VIEW.....	5
SPEAKER/POWER WIRE SOCKET DIAGRAM.....	6
REMOTE CONTROL.....	7
BATTERY INSTALLATION--REMOTE CONTROL.....	8
GENERAL OPERATIONS.....	9
LISTEN TO FM RADIO.....	10
BLUETOOTH PAIRING AND PLAYBACK.....	10
ADDING OPTIONAL EXTERNAL SUBWOOFER.....	11
CONNECT USING OPTICAL.....	12
CONNECT TO TV/DVD.....	13
AUX IN.....	14
USB.....	14
TROUBLESHOOTING GUIDE.....	15
SPECIFICATIONS.....	16

INTRODUCTION

Thank you for choosing a Connexx product. We hope you will find the Instructions in this owner's manual clear and easy to follow. If you take a few minutes to review, you will learn how to use all of the features of your new soundbar stereo for maximum enjoyment.

FEATURES

Features of the Connexx SBS-32Z4 soundbar stereo include:

Digital FM tuner w/10 presets

Bluetooth wireless technology

Built-in subwoofer (w/optional external subwoofer as an add-on accessory)

4 zone audio distribution

4 zone video distribution

3.5 mm aux input jack on front panel

USB input on front panel w/device charging capabilities

Digital Optical input on rear panel

2 analog stereo inputs on rear panel

LED backlit controls

Wireless remote control included

PACKING LIST

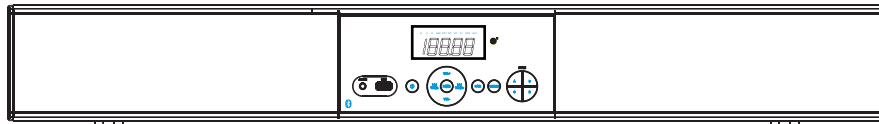

Main Unit



User Manual



Remote Control with Two Batteries

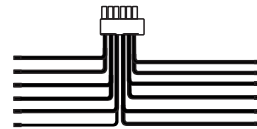

Wire Harness for Speakers



Wall Mounting Brackets



DC Power Extension (Red and Black) Wire

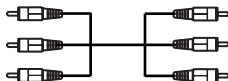

AV Connection Cable



FM Antenna

IMPORTANT SAFETY INSTRUCTIONS



CAUTION
RISK OF ELECTRIC SHOCK
DO NOT OPEN



CAUTION: TO REDUCE THE RISK OF ELECTRIC SHOCK, DO NOT REMOVE COVER (OR BACK). NO USER-SERVICEABLE PARTS INSIDE. REFER SERVICING TO QUALIFIED SERVICE PERSONNEL.



The lightning flash with arrowhead symbol within an equilateral triangle is intended to alert the user to the presence of uninsulated "dangerous voltage" within the product's enclosure that may be of sufficient magnitude to constitute a risk of electric shock to persons.



The exclamation point within an equilateral triangle is intended to alert the user to the presence of important operating and maintenance (servicing) instructions in the literature accompanying the appliance.

WARNING

USE UNDER SUPERVISION OF AN ADULT DUE TO LONG CORD

This unit has a long cord that can easily be tripped on or pulled on, causing injury. Please make sure it is arranged so it will not drape over a tabletop, etc. Where it can be pulled on by children or tripped over accidentally.

FCC NOTICE:

This equipment has been tested and found to comply with the limits for a Class B digital device, pursuant to part 15 of the FCC Rules. These limits are designed to provide reasonable protection against harmful interference in a residential installation. This equipment generates, uses and can radiate radio frequency energy and, if not installed and used in accordance with the instructions, may cause harmful interference to radio communications. However, there is no guarantee that interference will not occur in a particular installation. If this equipment does cause harmful interference to radio or television which can be determined by reception, turning the equipment off and on, the user is encouraged to try to correct the interference by one or more of the following measures:

- Reorient or relocate the receiving antenna. Increase the separation between the equipment and receiver.
- Connect the equipment into an outlet with a circuit different from that to which the receiver is connected.
- Consult the dealer or an experienced radio/TV technician for help.

FCC WARNING:

To assure continued compliance, follow the attached installation instructions and use only shielded cables when connecting to other devices. Modifications not authorized by the manufacturer may void user's authority to operate this device.

WARNING:

TO REDUCE THE RISK OF FIRE OR ELECTRIC SHOCK, DO NOT EXPOSE THIS PRODUCT TO RAIN OR MOISTURE.

WARNING:

TO REDUCE THE RISK OF FIRE OR ELECTRIC SHOCK, AND ANNOYING INTERFERENCE, USE THE RECOMMENDED ACCESSORIES ONLY.

Before using the unit, be sure to read all operating instructions carefully. Please note that these are general precautions and may not pertain to your unit.

1) Read these instructions

All the safety and operating instructions should be read before the product is operated.

2) Keep these instructions

The safety and operating instructions should be retained for future reference.

3) Heed all warnings

All warnings on the product and in the operating instructions should be adhered to.

4) Follow all instructions

All operating and use instructions should be followed.

5) Do not use this apparatus near water

Do not use this product near water and moisture, for example: near a bathtub, washbowl, kitchen sink or laundry tub; in a wet basement; or near a swimming pool.

6) Clean only with dry cloth

Unplug this product from the wall outlet before cleaning. Do not use liquid cleaners or aerosol cleaners. Use a dry cloth for cleaning.

7) Do not block any ventilation openings. Install in accordance with the manufacturer's instructions

Slots and openings in the cabinet and in the back or bottom are provided for ventilation, to ensure reliable operation of the product and to protect it from overheating. These openings must not be blocked or covered. The openings should never be blocked by placing the product on a bed, sofa, rug or other similar surface. This product should never be placed near or over a radiator or heat source. This product should not be placed in a built-in installation such as a bookcase or rack unless proper ventilation is provided or the manufacturer's instructions have been adhered to.

8) Do not install near any heat sources such as radiators, heat registers, stoves, or other apparatus(including amplifiers) that produce heat.

9) Do not defeat the safety purpose of the polarized or grounding-type plug. A polarized plug has two blades with one wider than other. A grounding type plug has two blades and a third grounding prong. The wide blade or the third prong are provided for your safety. If the provided plug does not fit into your outlet, consult an electrician for replacement of the obsolete outlet.

10) Protect the power cord from being walked on or pinched particularly at plugs, convenience receptacles, and the point where they exit from the apparatus.

11) Only use attachments/accessories specified by the manufacturer.

12) Unplug this apparatus during lightning storms or when unused for long periods of time

To protect your product from a lightning storm, or when it is left unattended and unused for long periods of time, unplug it from the wall outlet and disconnect the antenna or cable system. This will prevent damage to the product due to lightning and power-line surges.

13) Refer all servicing to qualified service personnel. Servicing is required when the apparatus has been damaged in any way, such as power-supply cord or plug is damaged, liquid has been spilled or objects have fallen into the apparatus, the apparatus has been exposed to rain or moisture does not operate normally, or has been dropped.

14) Power source

This product should be operated only from the type of power source indicated on the marking label. If you are not sure of the type of power supply to your home, consult your appliance dealer or local power company. For products intended to operate from battery power, or other source, refer to the operation instructions.

15) Service

Do not attempt to service this product yourself as opening or removing covers may expose you to dangerous voltage or other hazards. Refer all servicing to qualified service personnel.

WARNING:

To reduce the risk of fire or electric shock, do not expose this apparatus to rain or moisture. The apparatus shall not be exposed to dripping or splashing and that objects filled with liquids, such as vases shall not be placed on apparatus.

PLACING AND MOUNTING

1. Placing on the table

When placing the Sound Bar on an entertainment center, bookshelf, or any type of enclosed space, be sure to allow space around the Sound Bar for ventilation. If the Sound Bar is enclosed in a tight space, without ventilation, heat generated from the Sound Bar could produce a potential heat hazard.

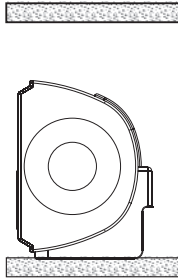

2. Mounting the Sound Bar onto a wall

We recommend having this Sound Bar professionally mounted. By using the included wall mounting accessories, the Sound Bar can be mounted onto a wall.



Distance between two brackets

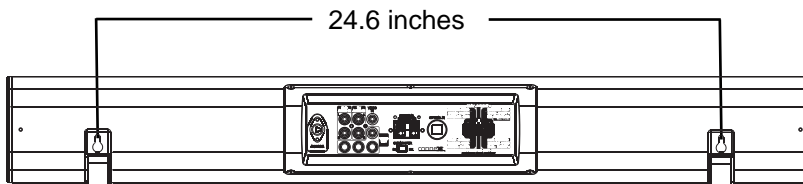

GENERAL VIEW

Front View

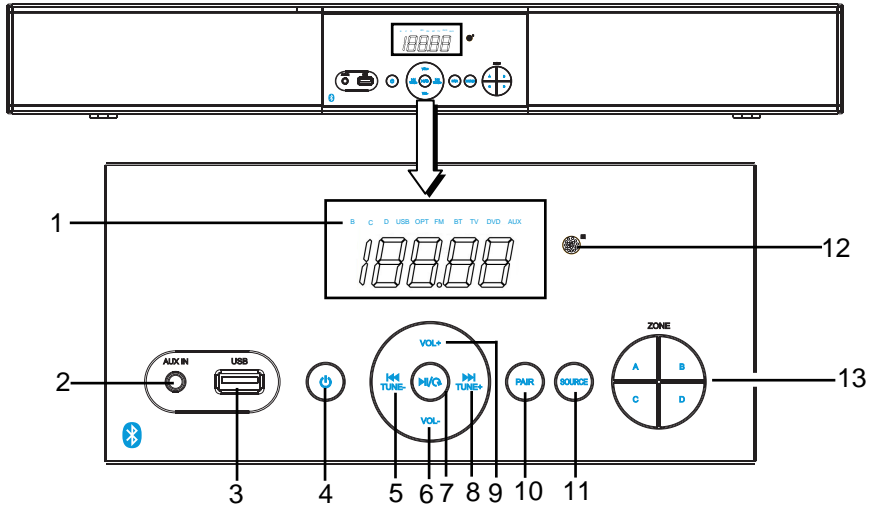

- | | | |
|-----------------|---|-------------------------|
| 1. LED Display | 5. PREVIOUS/TUNE Down | 9. Volume Up |
| 2. AUX IN Jack | 6. Volume Down | 10. PAIR Button |
| 3. USB Jack | 7. ▶ Play/Pause/ ◁ Preset/
Memory/Preset Play Button | 11. SOURCE Button |
| 4. POWER Button | 8. NEXT/TUNE Up | 12. Remote Sensor |
| | | 13. ZONE A/B/C/D Button |

Rear View

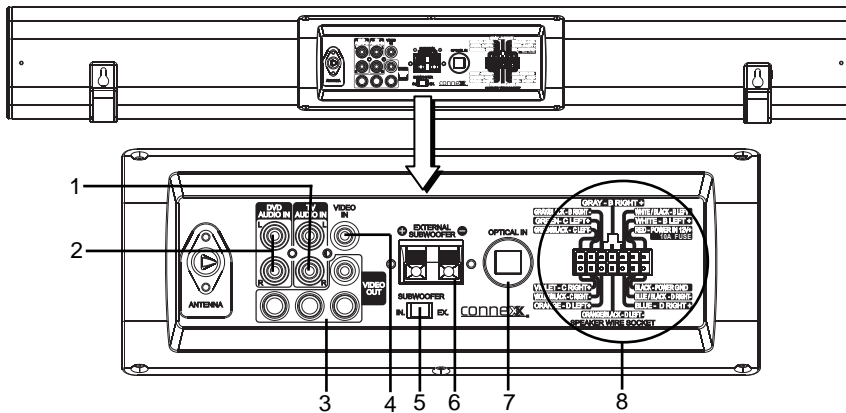

- | | |
|-----------------------|---------------------------------|
| 1. TV Audio In Jack | 5. Subwoofer Switch |
| 2. DVD Audio In Jack | 6. External Subwoofer Connector |
| 3. VIDEO Out Jack x 4 | 7. Optical In Power Jack |
| 4. VIDEO In Jack | 8. Speaker/Power Wire Socket |

SPEAKER/POWER WIRE SOCKET DIAGRAM

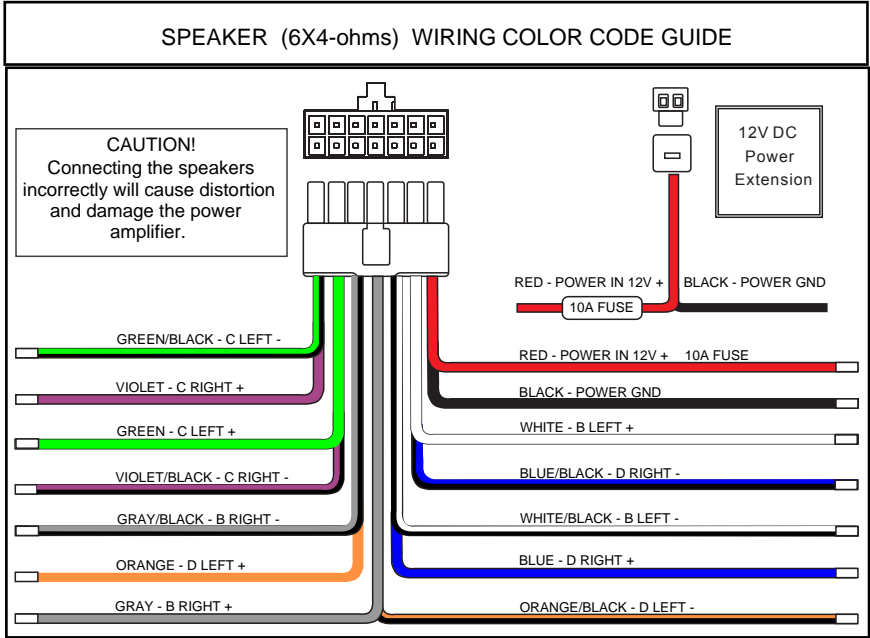
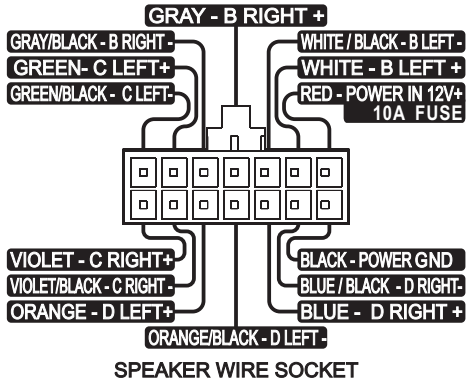

REMOTE CONTROL

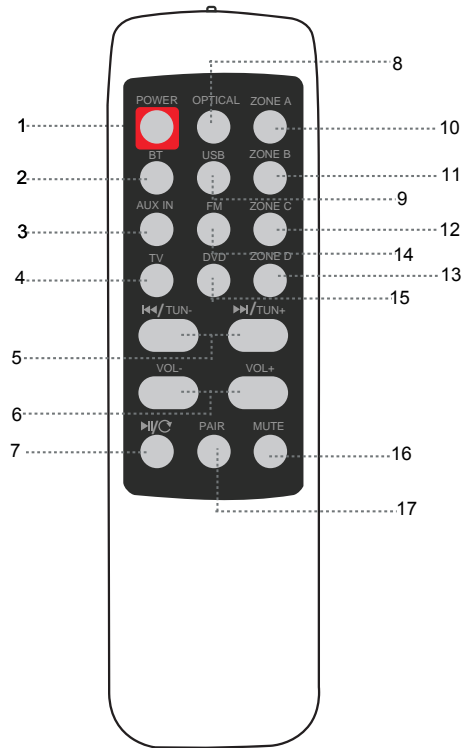

1. POWER button
2. Bluetooth Mode Switch button
3. AUX IN Mode Switch button
4. TV Mode Switch button
5. TUNE - / TUNE+ button
6. VOL (Volume)+/- buttons
7. PAUSE (Play/Pause)/MEMORY (Memory/ Preset /Preset Play)button
8. OPTICAL Mode Switch button
9. USB Mode Switch button

10. ZONE A button
11. ZONE B button
12. ZONE C button
13. ZONE D button
14. FM Mode Switch button
15. DVD Mode Switch button
16. MUTE button
17. PAIR button

BATTERY INSTALLATION--- REMOTE CONTROL

Battery Installation

1. Slide and lift the battery door (Figure 1).
2. Install 2 (two) AAA size batteries into the battery compartment as indicated by the polarity markings (Figure 2).
3. Replace the battery door (Figure 3).

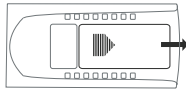

1

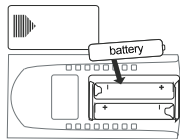

2

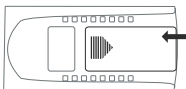

3

Battery Precaution

Follow these precautions when using a battery in this device:



1. Use only the size and type of battery specified.
2. Be sure to follow the correct polarity when installing the battery as indicated in the battery compartment. A reversed battery may cause damage to the device.
3. Do not mix different types of batteries together (e.g. Alkaline and Carbon-zinc) or old batteries with fresh ones.
4. If the batteries in the device are consumed or the device is not to be used for a long period of time, remove the batteries to prevent damage or injury from possible battery leakage.
5. Do not try to recharge the battery not intended to be recharged; it can overheat and rupture. (Follow battery manufacturer's instructions).
6. The batteries shall not be exposed to excessive heat such as sunshine, fire or the like.
7. Clean the battery contacts and also those of the device prior to battery installation.

Remote Control Effective Range

Notes:

- When there is an obstacle between the unit and the remote control, the remote control may not operate properly.
- When direct sunlight, an incandescent lamp, fluorescent lamp or any other strong light shines on the remote control of the unit, the remote control may not operate properly.

GENERAL OPERATIONS

1. Press the  Power button on the unit or remote control to power on the unit from standby mode.
2. The default mode is "FM". Press the SOURCE button repeatedly to switch to desired mode.
Follows the order below:
USB OPT FM BT TV DVD AUX
3. During Playback:
 - ~ Press the VOL (Volume)-/+ buttons to adjust volume level as desired.
 - ~ Press Mute button on the Remote Control to mute the sound on all active zones.
Press again to resume.
 - ~ Press ZONE A button on the Remote Control or on front panel of the sound bar to switch ON or OFF the soundbar speakers.
 - ~ Press ZONE B, ZONE C or ZONE D button on the Remote Control or on front panel to switch ON or OFF the corresponding ZONE B/C/D speakers.
4. When finished listening, press the  Power button to power off the unit.
5. If the unit is not used for long period of time, please disconnect power.

LISTEN TO FM RADIO

1. Power ON the unit.
2. Press the SOURCE button repeatedly until FM appears on the display.
Or press FM on Remote Control.
3. Press and hold the ◀◀ /TUNE - or ▶▶ /TUNE + buttons and then release,
The unit will start to search next (or previous) available FM radio station then plays.
4. When a station searched, press and hold the ⏸ button to display the desired storage location(such as Pxx.), then press ⏸ button to change the storage location, press and hold the ⏸ button to complete station storage.
A total of 10 stations can be stored into the unit's memory.
5. Press ⏸ button on remote control to play the preset stored station.

FM Antenna

The antenna wire on the rear of the unit is for radio reception. If reception is weak, unwind and extend the wire or relocate the wire to improve the radio reception.

BLUETOOTH PAIRING AND PLAYBACK

BT (Bluetooth):

Pairing the unit to external BT Device as follows:

1. Power ON the unit.
2. Press the SOURCE button repeatedly until "BT" appears on display.
Or press BT on Remote Control.
3. Turn on the external BT Device and enter BT searching mode. Start pairing as the screen instructions on the external BT Player.
(For details pairing procedures, please refer to the user's manual of your BT Device.)
Notes: ~ When the external BT Device searched the unit, "SBS-32Z4" will appear on the display of the external BT Device.
~ Pairing code "0000" may need to be entered.

Normal operation after paired:

--Press the VOL (Volume)-/+ buttons to adjust volume level as desired.

ADDING OPTIONAL EXTERNAL SUBWOOFER

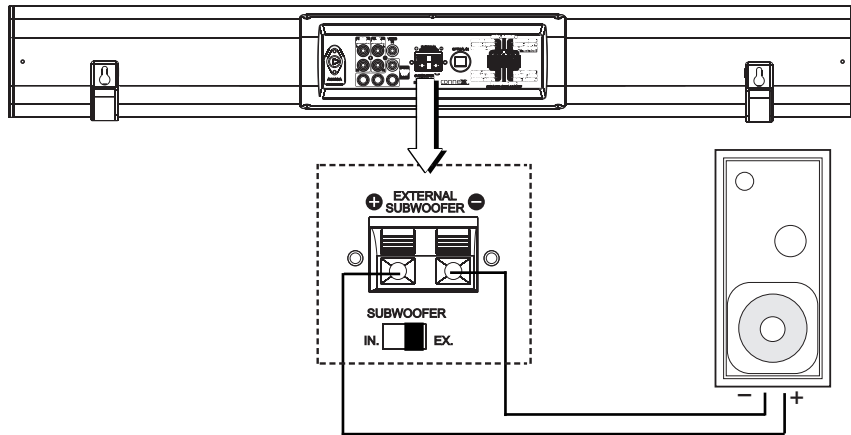

NOTE: Before connecting, disconnect power.

There is a SPEAKER SELECTOR on the back of the unit to turn on or turn off the internal subwoofer output or external subwoofer output.

IN(Internal subwoofer)-- When the switch is moved to "IN" position, there will be no audio output from the external subwoofer.

EX(External subwoofer)- When the switch is moved to "EX" position, there will be no audio output from the internal subwoofer.

1. Connect one end of subwoofer connection cable (not supplied) to the "+" Jack on the rear of the unit as the figure above.
2. Connect the other end to the "-" Jack on the rear of the unit as the figure above.
3. Slide the selector to "EX" position as figure above.
4. Power ON the unit.
5. Play the music as usual and set the desired volume.

CONNECT USING OPTICAL

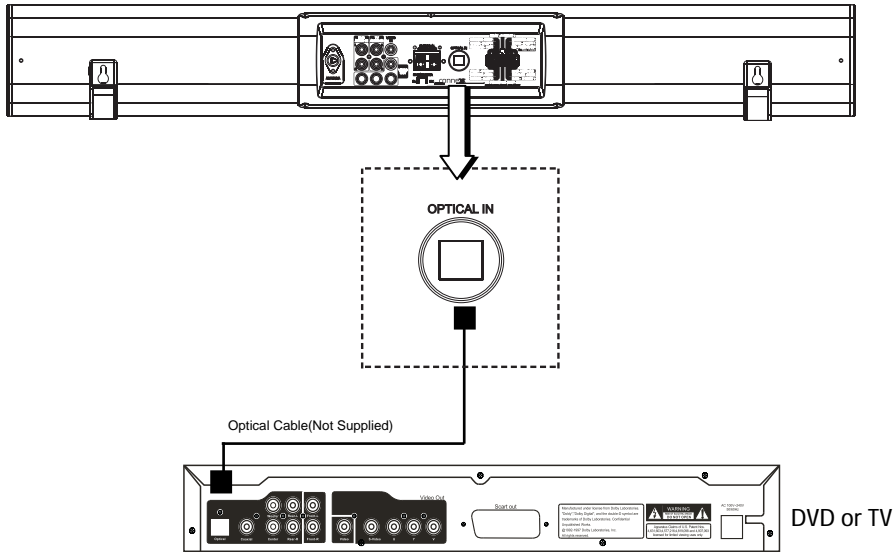

NOTE: Before connecting, disconnect power.

1. Connect one end of optical connection cable (not supplied) to the optical jack on the rear of the unit as pictured above.
2. Connect the other end to the DVD or TV back panel.
3. Power ON the unit.
4. Press the SOURCE button repeatedly until the "OPT" appears on display.
Or press OPTICAL on Remote Control.
5. Play the music as usual and set the desired volume.

NOTE:

If there is no audio output (only picture) when your TV or DVD player is connected to the soundbar, please check DVD audio setting, and set the digital output to PCM format.

CONNECT TO TV/DVD

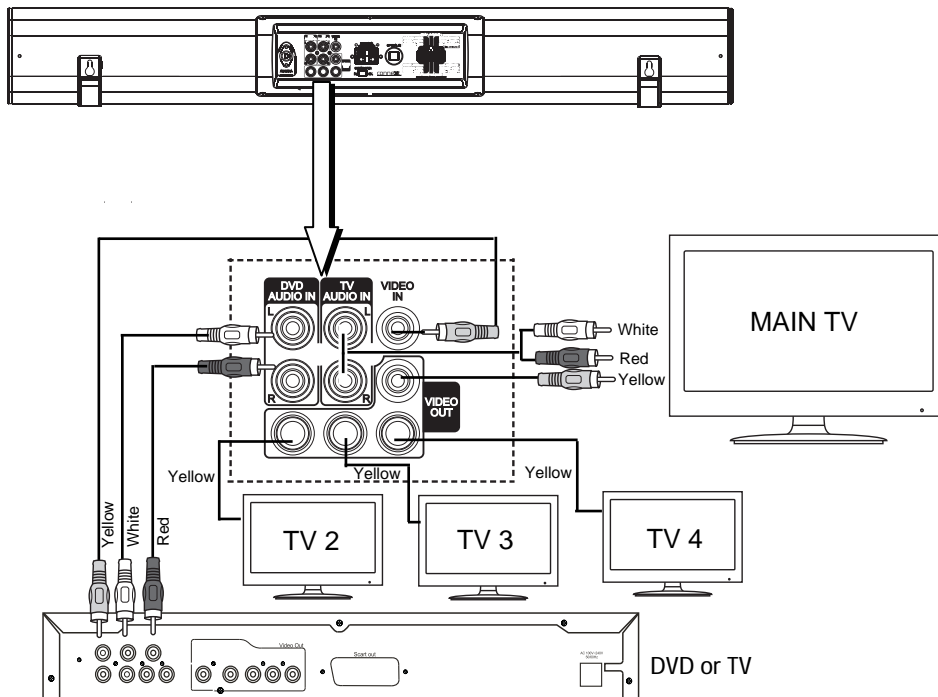

NOTE: Before connecting, disconnect power.

1. Connect as the figure above.(TV 2, 3, 4 are optional to connect)
2. Power ON the unit.
3. Press the SOURCE button repeatedly until "TV" appears on display.
TV audio is selected and will play through the unit.
Or press TV on Remote Control.
4. Press the SOURCE button repeatedly until "DVD" appears on display.
DVD audio is selected and will play through the unit.
Or press DVD on Remote Control.
5. Play the audio or video as usual and set the desired volume.

AUX IN : LISTEN TO EXTERNAL AUDIO DEVICES

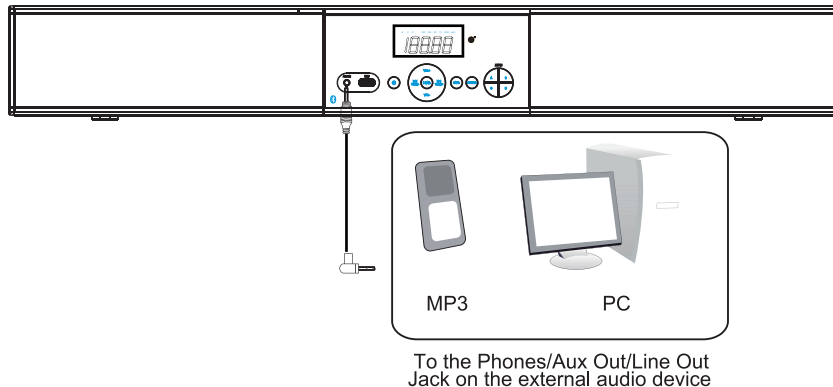

1. Connect one end of audio connection cable (not supplied) to the AUX IN jack on the front of the unit as pictured above.
2. Connect the other end to the Audio out/Line out/Phone jack on the external player (such as iPod, iPhone, iPad, MP3 player, Discman... etc.)
3. Power ON the unit.
4. Press the SOURCE button repeatedly until "AUX" appears on display.
Or press AUX IN on Remote Control.
5. Play the music in the external player as usual and set the desired volume.

USB : LISTEN TO EXTERNAL AUDIO DEVICES

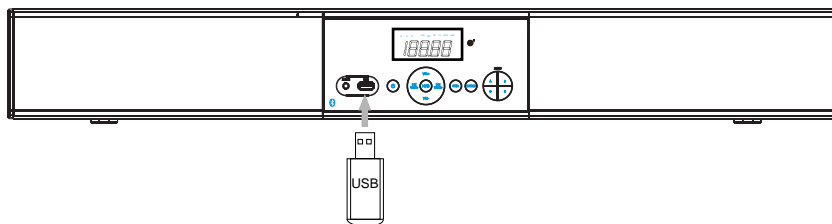

1. Insert the USB as in the figure above.
2. Power ON the unit.
3. Insert the USB, then press the SOURCE button repeatedly until "USB" appears on screen.
Or press USB on Remote Control.
4. Play the music in the external player as usual and set the desired volume.
 - ~ Press ►|| button on the Remote Control to play or pause.
 - ~ Press ◀◀ or ▶▶ button on the Remote Control to skip to next or previous track.

NOTE:

The USB port can also be used for charging.

TROUBLESHOOTING GUIDE

Check the following guide before requesting service		
SYMPTOM	POSSIBLE CAUSE	POSSIBLE SOLUTION
No power	power cable not connected or blown fuse	~Check fuse ~Check 12V connection
No sound	Volume in minimum position	Raise volume level by pressing the VOL (Volume) + button
	The connected device is not in playback mode	Play the music/movie in the connected device as usual and make sure the volume level of it is in high level
	Input source incorrect	Press the SOURCE button repeatedly to set the input source to the desired mode
Sound distortion	Bass level of the connected device too high	Reduce the bass level of the connected device
	Volume level too high	Reduce the volume level by pressing the VOL (Volume) - button
Remote not working	The batteries are consumed	Replace with new batteries
Bluetooth reception failure	The external device is too far from the unit	Move the external BT device closer to the unit
	Have not paired	Pair both units

SPECIFICATIONS

Operation Voltage.....	DC10V-14V
Power Supply Requirement.....	DC 12 Volts, Negative Ground
Overall Dimension.....	813(W)x107.2(H)x83(D)mm
Device and Accessories Net Weight.....	2.2kg(4.85 lb)
Max Power Consumption.....	90W
Video In/Out Level.....	1 Vp-p/Load impedance:75 ohm
Radio Coverage	FM 87.5 -108.0 MHz
Bluetooth Effective Range.....	Up to 30 feet (Measured in open area. Wall and structures may affect the effective range.)
Remote Effective Range.....	Up to 15 feet

Specifications subject to change without notice.

FCC WARNINGS:

The device complies with Part 15 of the FCC rules. Operation is subject to the following two conditions.

- (1) The device may cause harmful interference. and
- (2) This device must accept any interference received, including the interference that may cause undesired operation.

Changes or modifications not expressly approved by the party responsible for compliance could void the user's authority to operate the equipment.

NOTE:

THE MANUFACTURER IS NOT RESPONSIBLE FOR ANY RADIO OR TV INTERFERENCE CAUSED BY UNAUTHORIZED MODIFICATIONS TO THIS EQUIPMENT. SUCH MODIFICATIONS COULD VOID THE USER'S AUTHORITY TO OPERATE.

 RIVERPARK

www.riverparkinc.com

© 2014 RIVERPARK Inc.

V. 050514