

SAIKYO

LED TV / DVD Téléviseur LED / DVD

USER MANUAL MANUEL D'UTILISATION



The terms HDMI and HDMI High-Definition Multimedia Interface, and the HDMI Logo are trademarks or registered trademarks of HDMI Licensing LLC in the United States and other countries.

ENERGY STAR® Qualification.

Enabling certain features and functionality in this product (e.g. Picture Mode, Volume) may increase its energy consumption, possibly beyond the limits required for ENERGY STAR® qualification.

This product has earned the ENERGY STAR® qualification meeting US Federal Energy efficiency guidelines as established by the Department of Energy and Environmental Protection Agency. The ENERGY STAR® program exists to provide energy saving guidelines and help promote energy efficient products and practices.

Power Saving Mode is the mode in which the product qualifies for ENERGY STAR®.

HDMI, le logo HDMI et High-Definition Multimedia Interface sont des marques commerciales ou des marques de commerce déposées de HDMI Licensing LLC aux États-Unis et dans d'autres pays.

L'activation de certaines fonctions et fonctionnalités sur ce produit (p. ex. Mode image, Volume) peut augmenter sa consommation d'énergie, probablement au-delà des limites requises pour la qualification ENERGY STAR®.

L'homologation ENERGY STAR® a été conférée à ce produit en conformité aux normes d'efficacité de la Commission fédérale de régulation de l'énergie (É.-U.) établies par le Ministère de l'énergie et l'Agence pour la protection de l'environnement. Le programme ENERGY STAR® existe pour fournir des directives relatives aux économies d'énergie et pour contribuer à la promotion de produits et de pratiques efficaces du point de vue énergétique.

IMPORTANT

Please read this manual carefully before installing and operating the TV.

Keep this manual handy for further reference

IMPORTANT

Veuillez lire ce manuel attentivement avant d'installer et d'utiliser le téléviseur.

Conservez ce manuel à portée de main pour toute consultation ultérieure.

TABLE OF CONTENTS

Preparations Guide

Safety Information.....	2
Important Safety Instructions.....	3-7

Install and Connect TV

TV Buttons and Connections.....	8
External Device Connection Diagram	9
Install and Connect TV.....	10
TV Stand Installation Instructions.....	10

Setup Wizard

Setup Wizard	11-12
--------------------	-------

Select Input Source

Select Input Source.....	13
--------------------------	----

TV

Main Menu Operation.....	14-16
Sound Menu.....	16-17
Time Menu.....	18
Setup Menu.....	19
Close Caption.....	20
Lock Caption.....	23
US Rating.....	24
TV	24
MPAA	26
Canada Rating.....	26
Hotel Menu.....	27-28
Channel Menu.....	29

PC



PC Menu.....	31-32
--------------	-------

DVD

DVD	33-34
-----------	-------

Other Information

Help.....	35
Specifications.....	36
Remote Control Diagram.....	37

	CAUTION / ATTENTION RISK OF ELECTRIC SHOCK, DO NOT OPEN RISQUE D'ELECTROCUTION, NE PAS OUVRIR.	
<p>CAUTION: TO REDUCE THE RISK OF ELECTRIC SHOCK, DO NOT REMOVE COVER (OR BACK). NO USER-SERVICEABLE PARTS INSIDE. REFER SERVICING TO QUALIFIED SERVICE PERSONNEL.</p>		



The lightning flash with arrowhead symbol, within an equilateral triangle is intended to alert the user to the presence of uninsulated dangerous voltage within the product's enclosure that may be of sufficient magnitude to constitute a risk of electric shock.



The exclamation point within an equilateral triangle is intended to alert the user to the presence of important operating and maintenance (servicing) instructions in the literature accompanying the appliance.

<p>WARNING: TO PREVENT FIRE OR SHOCK HAZARD, DO NOT EXPOSE THIS APPLIANCE TO RAIN OR MOISTURE. TO PREVENT THE SPREAD OF FIRE, KEEP CANDLES OR OPEN FLAMES AWAY FROM THIS PRODUCT AT ALL TIMES.</p> <p>CAUTION: TO PREVENT ELECTRIC SHOCK. DO NOT USE THIS POLARIZED PLUG WITH AN EXTENSION CORD, RECEPTACLE OR OTHER OUTLET UNLESS THE BLADES CAN BE FULLY INSERTED TO PREVENT BLADE EXPOSURE.</p>
--

WARNING: This equipment has been tested and found to comply with the limits for a Class B digital device, pursuant to Part 15 of the FCC Rules. These limits are designed to provide reasonable protection against harmful interference in a residential installation. This equipment generates, uses and can radiate radio frequency energy and, if not installed and used in accordance with the instructions, may cause harmful interference to radio communications. However, there is no guarantee that interference will not occur in a particular installation. If this equipment does cause harmful interference to radio or television reception, which can be determined by turning the equipment off and on, the user is encouraged to try to correct the interference by one or more of the following measures:

- Reorient or relocate the receiving antenna.
- Increase the separation between the equipment and receiver.
- Connect the equipment into an outlet on a circuit different from that to which the receiver is connected.
- Consult the dealer or an experienced radio/TV technician for help.

CAUTION: Changes or modifications not expressly approved by the party responsible for compliance with the FCC Rules could void the user's authority to operate this equipment.

<p>FCC Declaration of Conformity Compliance statement (Part 15):</p> <p>This device complies with Part 15 of the FCC rules. Operation is subject to the following two conditions: (1) this device may not cause harmful interference, and (2) this device must accept any interference received, including interference that may cause undesired operation. The party responsible for compliance to these rules is:</p> <p>ORION SALES, INC. 3471 N. UNION DR. OLNEY, ILLINOIS 62450, U.S.A Ph: 1-800-289-0980</p>
--

Important Safety Instructions

1. Read these instructions.
2. Keep these instructions.
3. Heed all warnings.
4. Follow all instructions.
5. Do not use this apparatus near water.
6. Clean only with dry cloth.
7. Do not block any ventilation openings. Install in accordance with the manufacturer's instructions.
8. Do not install near any heat sources such as radiators, heat registers, stoves, or other apparatus (including amplifiers) that produce heat.
9. Do not defeat the safety purpose of the polarized or grounding-type plug. A polarized plug has two blades with one wider than the other. A grounding type plug has two blades and third grounding prong. The wide blade or third prong is provided for your safety. When the provided plug does not fit into your outlet, consult an electrician for replacement of the obsolete outlet.
10. Protect the power cord from being walked on or pinched, particularly at plugs, convenience receptacles, and the point where they exit from the apparatus.
11. Only use attachments/accessories specified by the manufacturer.
12.  Use only with the cart, stand, tripod, bracket, or table specified by the manufacturer, or sold with the apparatus. When a cart is used, use caution when moving the cart/apparatus combination to avoid injury tip-over.
13. Unplug this apparatus during lightning storms or when unused for long periods of time.
14. Refer all servicing to qualified service personnel. Servicing is required when the apparatus has been damaged in any way, such as power-supply cord or plug is damaged, liquid has been spilled or objects have fallen into the apparatus, the apparatus has been exposed to rain or moisture, does not operate normally, or has been dropped.
- 15) Warning to reduce the risk of fire or electric shock, do not expose this apparatus to rain or moisture. Apparatus should not be exposed to dripping or splashing, and objects filled with liquids, such as vases, should not be placed on the apparatus.
- 16) An outside antenna system should not be located in the vicinity of overhead power lines or other electric light or power circuits, or where it can fall into such power lines or circuits. When installing an outside antenna system, extreme care should be taken to keep from touching such power lines or circuits, as contact with them might be fatal.
- 17) Do not overload wall outlets and extension cords, as this can result in a risk of fire or electric shock.
- 18) Do not push objects through any openings in this unit, as they may touch dangerous voltage points or short out parts that could result in fire or electric shock. Never spill or spray any type of liquid into the unit.

Important Safety Instructions

19) If an outside antenna or cable system is connected to the unit, be sure the antenna or cable system is grounded to provide some protection against voltage surges and built-up static charges, Section 810 of the National Electrical Code, ANSI/NFPA 70, provides information with respect to proper grounding of the mast and supporting structure, grounding of the lead-in wire to an antenna discharge unit, size of grounding conductors, location of antenna discharge unit, connection to grounding electrodes, and requirements for the grounding electrode.

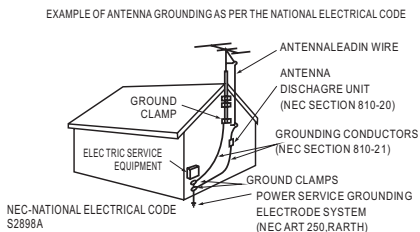

20) When replacement parts are required, be sure the service technician uses replacement parts specified by the manufacturer or those that have the same characteristics as the original part. Unauthorized substitutions may result in fire, electric shock or other hazards.

21) Upon completion of any service or repairs to this unit, ask the service technician to perform safety checks to determine that the unit is in proper operating condition.

22) When you connect the product to other equipment, turn off the power and unplug all of the equipment from the wall outlet. Failure to do so may cause an electric shock and serious personal injury. Read the owner's manual of the other equipment carefully and follow the instructions when making any connections.

23) Sudden high volume sound may cause hearing or speaker damage. When you use headphones, (if the unit is equipped with a headphone jack) keep the volume at a moderate level. If you use headphones continuously with high volume sound, it may cause hearing damage.

24) Do not allow the product to output distorted sound for an extended period of time. It may cause speaker overheating and fire.

25) This reminder is provided to call the cable TV system installer's attention to Article 820-40 of the NEC that provides guidelines for proper grounding and, in particular, specifies that the cable ground shall be connected to the grounding system of the building, as close to the point of cable entry as practical.

26) Where the mains plug is used as the disconnect device, the disconnect device shall remain readily operable.

27) Explanation of symbol, marking, signal lamp or similar means indicate that apparatus is completely disconnected from the mains.  This equipment is a Class II or double insulated electrical appliance. It has been designed in such a way that it does not require a safety connection to electrical earth.

28)  Correct Disposal of this product. This marking indicates that this product should not be disposed with other household wastes throughout the EU. To prevent possible harm to the environment or human health from uncontrolled waste disposal, recycle it responsibly to promote the sustainable reuse of material resources. To return your used device, please use the return and collection systems or contact the retailer where the product was purchased.

Important Safety Instructions

CHILD SAFETY:

It Makes A Difference How and Where You Use Your Flat Panel Display

Congratulations on your purchase! As you enjoy your new product, please keep these safety tips in mind:

THE ISSUE

The home theater entertainment experience is a growing trend and larger flat panel displays are popular purchases. However, flat panel displays are not always supported on the proper stands or installed according to the manufacturer's recommendations.

Flat panel displays that are inappropriately situated on dressers, bookcases, shelves, desks, speakers, chests or carts may fall over and cause injury.

THIS MANUFACTURER CARES!

The consumer electronics industry is committed to making home entertainment enjoyable and safe.

TUNE INTO SAFETY

One size does NOT fit all. Follow the manufacturer's recommendations for the safe installation and use of your flat panel display.

Carefully read and understand all enclosed instructions for proper use of this product. Don't allow children to climb on or play with furniture and television sets.

Don't place flat panel displays on furniture that can easily be used as steps, such as a chest of drawers.

Remember that children can become excited while watching a program, especially on a "larger than life" flat panel display. Care should be taken to place or install the display where it cannot be pushed, pulled over, or knocked down.

Care should be taken to route all cords and cables connected to the flat panel display so that they cannot be pulled or grabbed by curious children.

Warning: batteries(pack or batteries installed) should not be exposed to excessive heat such as sunshine, fire or other heat sources.

Important Safety Instructions

CONDENSATION

Moisture will form in the operating section of the unit if the unit is brought from cool surroundings into a warm room or if the temperature of the room rises suddenly. When this happens, unit's performance will be impaired. To prevent this, let the unit stand in its new surroundings for about an hour before switching it on, or make sure that the room temperature rises gradually.

Condensation may also form during the summer if the unit is exposed to the breeze from an air conditioner. In such cases, change the location of the unit.

HOW TO HANDLE THE LCD PANEL

- Do not press hard or jolt the LCD panel. It may cause the LCD panel glass to break and injury may occur.
- If the LCD panel is broken, make absolutely sure that you do not touch the liquid in the panel. This may cause skin inflammation.

If the liquid gets in your mouth, immediately gargle and consult with your doctor. Also, if the liquid gets in your eyes or touches your skin, consult with your doctor after rinsing for at least 15 minutes or longer in clean water.

Possible Adverse Effects on LCD Panel: If a fixed (non-moving) pattern remains on the LCD Panel for long periods of time, the image can become permanently engrained in the LCD Panel and cause subtle but permanent ghost images. This type of damage is NOT COVERED BY YOUR WARRANTY. Never leave your LCD Panel on for long periods of time while it is displaying the following formats or images:

- Fixed Images, such as stock tickers, video game patterns, TV station logos, and websites.
- Special Formats that do not use the entire screen. For example, viewing letterbox style (16:9) media on a normal (4:3) display (black bars at top and bottom of screen); or viewing normal style (4:3) media on a widescreen (16:9) display (black bars on left and right sides of screen).

The following symptoms are not signs of malfunction but technical limitation. Therefore we disclaim any responsibility for these symptoms.

LCD Panels are manufactured using an extremely high level of precision technology, however sometimes parts of the screen may be missing picture elements or have luminous spots. This is not a sign of a malfunction.

Do not install the LCD Panel near electronic equipment that produces electromagnetic waves. Some equipment placed too near this unit may cause interference.

Effect on infrared devices – There may be interference while using infrared devices such as infrared cordless headphones.

Important Safety Instructions

The unit emits heat when in operation. Do not place any covers or blankets on the unit, this may cause overheating. Do not block ventilation holes, or set up near radiators. Do not place in direct sunshine. When placing on a shelf 10 cm (4 inches) free space must be available around the entire unit.

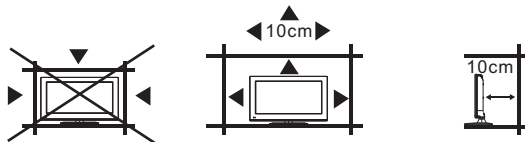

Notes when mounting the LCD TV on a wall

- If the unit is to be mounted on the wall, contact the retailer where you purchased the LCD TV for advice, and have the equipment professionally installed. Incomplete or improper installation may cause injury to you, and/or damage to the LCD TV.
- Bracket holes: To attach a wall mounting bracket (not supplied) attach where indicated in the drawing below.
- This manufacturer recommends professional installation.
- Utilize an appropriate bracket and fasteners, sufficient to accommodate the size and weight of the unit.
- Assure the wall to which the unit is to be mounted will safely support the size and weight of the unit, using the bracket and fasteners you have selected.
- Keep cords and cables connected to this flat panel display out of reach of children.
- To hang the television on a wall, remove the screws and then remove the stand. Before performing work spread cushioning over the base area to lay the TV on.

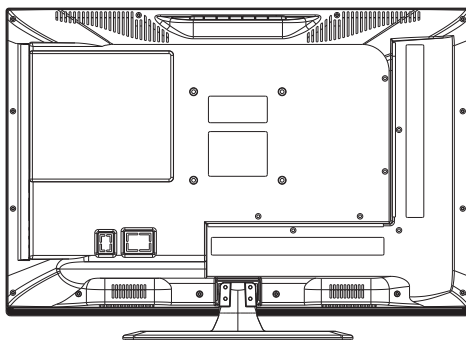

Note: Drawing is a representative example only

TV Buttons and Connections

TV Buttons

Note: The following is only a representation of the buttons on your unit. The actual position and arrangement of the buttons may differ by model.



: Turn ON/OFF Power.

SOURCE: External Signal Input Selection.

MENU: Display Main MENU And Confirm MENU Item Selection.

CH+/-: Select Channel.

VOL+/-: Adjust Volume.

Connections

Note: The following are the various connections available, the actual position and arrangement and the number of each type may differ by model. Some models do not have all available connections.

	AV Input External AV Signal Input and Right/Left Audio Inputs.		HEADPHONE JACK Plug earphones into jack for private listening. Overrides speakers.
	AV Output External AV Signal Output and Right/Left Audio Outputs.		USB Input This input is for service personnel only.
	Component Input Connect to a component output connection on your external device.		COAXIAL Output Connect to your SPDIF device
	HDMI Input Connect to a HDMI output connection on your external device.		Output Audio Out Right/Left Connect to your external device.
	ANT 75/RF Connection Connect to the antenna/cable TV output of your device or wall plate.		OPTICAL Digital Audio Output.
	VGA Input Connect to your PC using a VGA cable(not provided).		
	PC Audio Input Connect to your PC Audio Out using 1/8 line cord.		

External device connection diagram

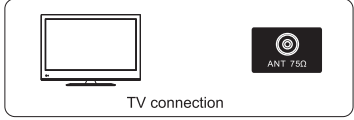
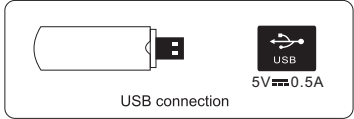
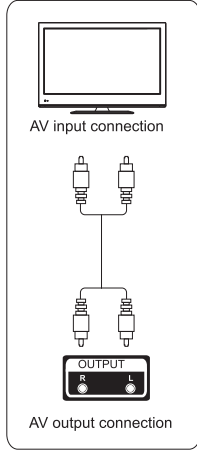
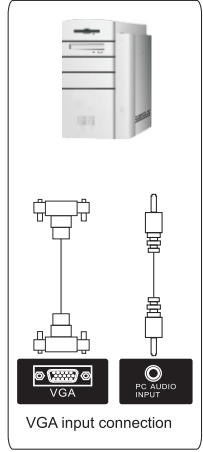
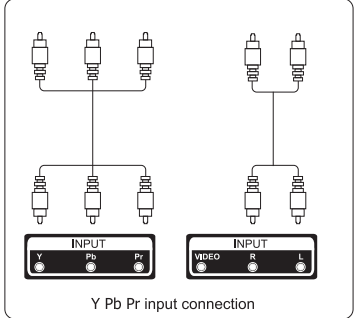
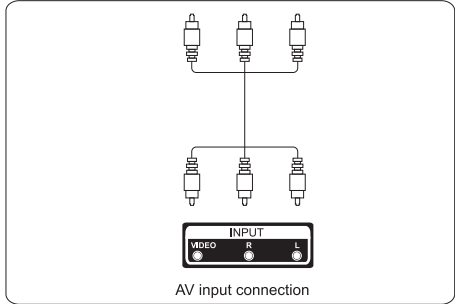
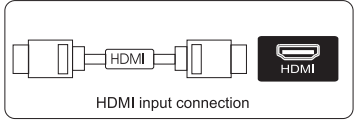
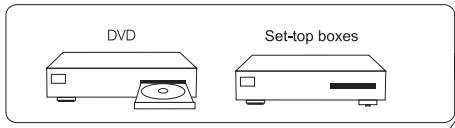

Install and Connect TV

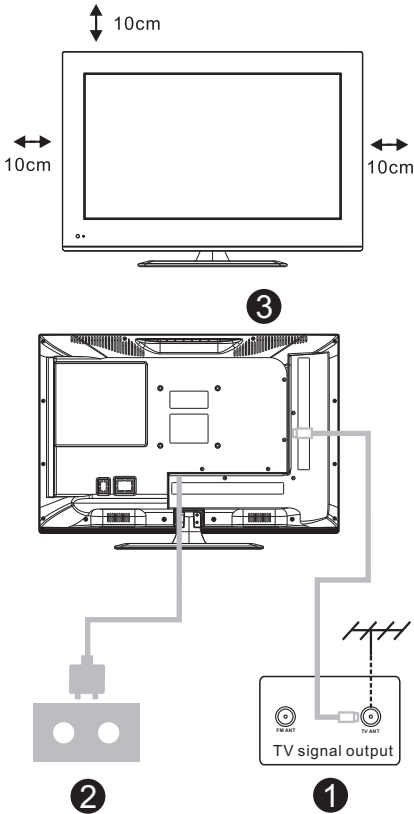

Set your TV

1. Put your TV in a place that can bear the weight of the TV.
To avoid danger, please do not assemble the TV near water or extreme heat (such as a furnace, light source, or candle.)
Do not block the ventilation on the back of the TV.

Connect antenna and power

2. Connect the antenna cable to the RF connection on the back of the TV.
Plug the TV into the wall power outlet (AC120~ 60Hz).

Turn on the TV

3. While in standby mode the power indication light will be red. Press the power button on the TV or remote control. The light will change to green.

Note:

Picture for reference purposes only.

TV Stand Installation Instructions

TV Stand Installation Instructions

1. Open the carton and remove the TV, accessories, and base.
2. To avoid injury to the TV, place the TV face down on a firm surface, covered with a soft cloth. Attach the neck to the TV with the supplied screws.
3. Attach the base to the neck with the supplied screws.
4. Note: Insufficient tightening or incorrect installation of the stand will not support your unit correctly, and could result in damage or injury from a tip-over.

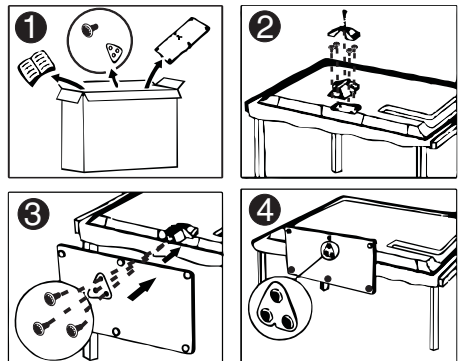

Setup Wizard

Setup Wizard

If your preferred language is French or Spanish, exit this Setup Wizard by pressing the Menu button, and follow the instruction on page 19 to make your language selection and re-enter the Setup Wizard from that Menu screen.

Connect a RF cable from your incoming antenna/cable jack to the TV's input labeled "ANT".

Select TV Location

Press ◀/▶ button to select the TV Location to be used.

Press ▼/▲ button to select - Go to next step - and press ENTER / ▶ .

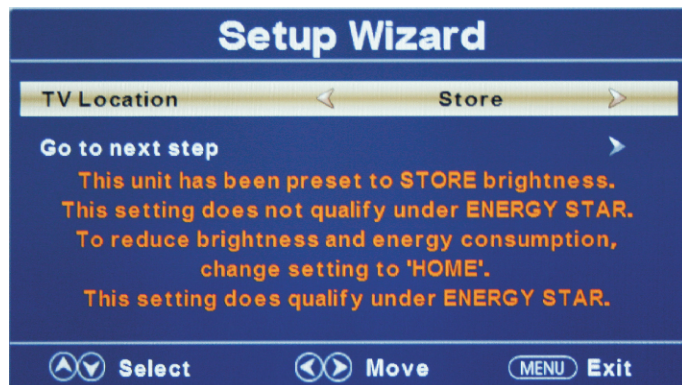

Select Time

Press ▼/▲ button to select the time zone, daylight saving time and time format you prefer.

Press ◀/▶ button on the remote control to adjust.

Press ▼/▲ button on the remote control to select - Go to next step - and press ENTER / ▶ .

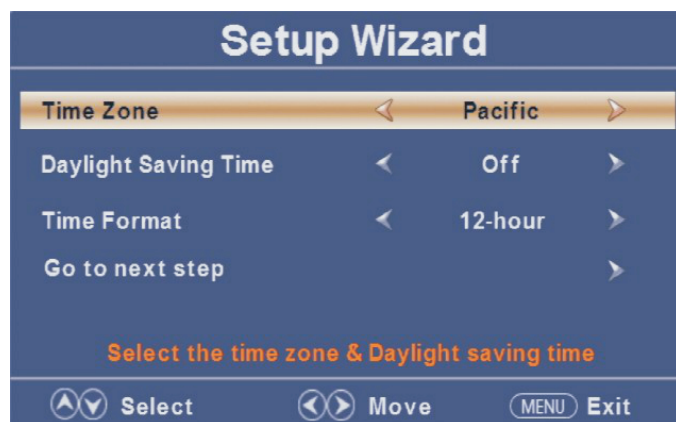

Setup Wizard

Auto Scan

Press ◀/▶ to select the antenna type.

Press ▼/▲ button to select - Go to next step - and press the ENTER/▶ button to start auto scan.



Select Input Source

THE NUMBER OF HDMI CONNECTIONS MAY DIFFER DEPENDING UPON MODEL SIZE

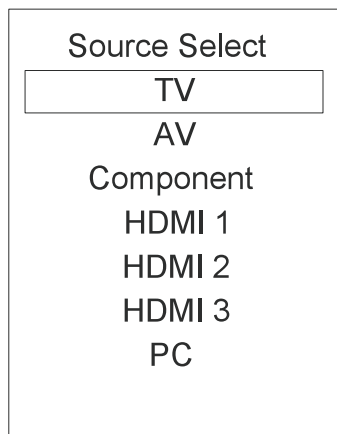

Press the **INPUT** button to display the input source list.

Press **▼ / ▲** or **INPUT** to choose your signal source.

Press **ENTER** to confirm your selection.

Press **EXIT** to leave the Source Menu.

Main Menu



Press **MENU** to display the Main menu, return to the previous menu, or close the Main menu.
Press **◀ / ▶** to highlight the desired menu icon, and press **ENTER** to select.

TV

Main Menu Operation

Picture Menu

Press **MENU** to enter the Main menu, press ◀ / ▶ button to select.

Press **ENTER** / ▼ to make your selection

Press **MENU** again to exit or return to the Main menu.

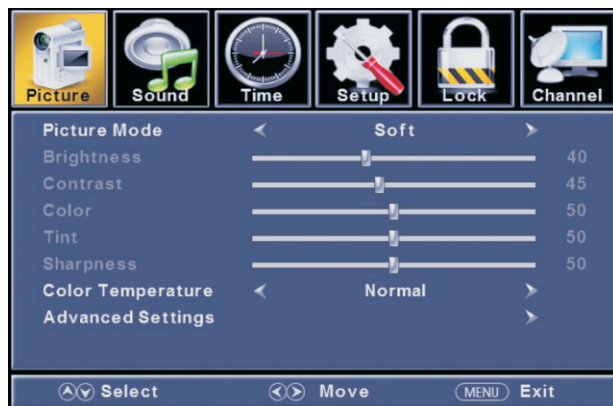

Press ▼ / ▲ button to choose Picture Mode / Color Temperature/ Advanced Settings.

Press **ENTER** to select.

Press ◀ / ▶ to adjust.

Press **MENU** again to return to the Main menu.

【Picture Mode】

Adjust picture mode to change picture appearance.

Press ◀ / ▶ button to select (Standard / Dynamic / Soft / User / Power saving).

Note: The brightness, contrast, color, tint and sharpness adjustments are available only in User Mode.

Standard Produces a highly defined image in a normally lit room.

Dynamic Produces a highly defined image in a brightly lit room.

Soft Produces a highly defined image in a softly lit room.

User Select to customize picture settings.

Power saving Produces a lower power consumption mode.

【Brightness】

Adjust the visual perception output of the entire picture; it will affect the luminousness of the picture.

Press ◀ / ▶ button to adjust.

【Contrast】

Adjust the highlight intensity of the picture, but the shadow of the picture is invariable.

Press ◀ / ▶ button to adjust.

TV

【Color】

Adjust the saturation of the color based on your preference.
Press ◀ / ▶ button to adjust

【Tint】

Adjust the hue (Red, Green, Blue) of the picture.
Press ◀ / ▶ button to adjust

【Sharpness】

Adjust the detail of the picture.
Press ◀ / ▶ button to adjust

【Color Temperature】

Increase or reduce warm color tones (reds), and the cool color tones (blues) according to your preference.

Normal	Preset color selection.
Warm	Increase the red color tone.
Cool	Increase the blue color tone.

【Advanced Settings】

Adjust advanced video features to fine tune the picture.
Press ▶ button to enter the sub-menu.



【Aspect Ratio】

Adjust how the picture fills the screen.

Normal	Automatically adjusts Aspect Ratio based on TV size and TV program.
Wide	Use to watch wide screen (16:9) content.
Zoom	Expands image to fill the screen. Top and bottom may be cut off.
Cinema	Stretches image at edges but keeps a clear image in the center.

【Noise Reduction】

Set options to reduce video noise.

Off	Select to turn off video noise detection.
Low	Detect and reduce low video noise.
Medium	Detect and reduce moderate video noise.
High	Detect and reduce enhanced video noise.
Auto	Detect and reduce video noise automatically.

TV

【Dynamic Contrast】

Automatically adjust picture detail and brightness.
Press ◀/▶ to select (Off/On)

【HDMI Mode】

Only available if you are connected using the HDMI input.
Press ◀/▶ button to select (Video/Graphic).

Sound Menu

Press **MENU** to enter the Main menu, Press ◀/▶ button to select Sound.
Press **ENTER** / ▼ to enter the menu.
Press **MENU** again to exit or return to the Main menu.



Press ▼ / ▲ button to choose the Sound Mode Equalizer / Bass / Treble / Balance / MTS / Audio Language / Digital Audio Output/ Surround Sound/AVL.
Press **ENTER** / ▼ to enter.
Press ◀ / ▶ button to adjust.
Press **MENU** again to exit or return to the Main menu.

TV

【 Sound Mode 】

Select a sound mode to achieve ideal sound.

Press ◀/▶ button to select (Standard / Music / Movie / Sports / User).

Note: The bass and treble are only available in User mode.

Standard	Produces a balanced sound in all environments.
Music	Preserves the original sound. Good for musical programs.
Movie	Enhances treble and bass for a rich sound experience.
Sports	Enhances vocals for TV audio.
User	Select to customize audio settings.

【 Bass 】

Adjust the bass effect. Increases or decreases lower-pitched sounds.

Press ◀/▶ button to adjust

【 Treble 】

Adjust the treble effect. Increases or decreases high-pitched sounds.

Press ◀/▶ button to adjust.

【 Balance 】

Adjust the balance between left and right speakers to adapt to your listening position.

Press ◀/▶ button to adjust.

【 MTS 】

Configures the multi-track sound, it is only available in ATV.

Press ◀/▶ button to select (Mono/Stereo/SAP)

Mono	Sets the sound to mono.
Stereo	Sets the sound to stereo when stereo is not available, the sound is automatically switched to mono.
SAP	Sets the sound to the second audio program.

【 Audio Language 】

Select the language supported by the chosen digital channel. This feature is only available in DTV.

Press ◀/▶ button to select (English / French / Spanish).

【 Digital Audio Output 】

Send digital audio to external audio system.

Press ◀/▶ button to select.

PCM	Select to output audio in 2-channel stereo.
Raw	Original image coded date.
Off	Set digital audio output off.

【 AVL 】

Set the auto volume control.

Press ◀/▶ button to select (On / Off).

NOTE:

Balance: This feature adjusts the speaker's output; it enables you to adjust the volume level of your speakers to suit your preference.

AVL: This feature balances the volume variance between different scenes automatically. This function will also reduce the fluctuation of the sound.

TV

Time Menu

Press **MENU** to enter the Main menu, Press ◀/▶ button to select **Time**.

Press **ENTER** / ▼ to enter

Press **MENU** again to exit or return to the MAIN menu.



Press ▼ / ▲ button to select among Sleep Timer / Time Zone / Daylight Saving Time / Time Format / Auto Clock / Clock.

Press **ENTER** / ▼ to enter.

Press ◀/▶ button to adjust.

Press **MENU** again to exit or return to the MAIN menu.

【Sleep Timer】

Set a timer for the TV to turn off automatically.

Press◀/▶ button to select (Off / 5min/10min/15min/ 30min / 60min / 90min / 120min/180min/240min).

【Time Zone】

Select your time zone.

Press◀/▶ button to select (Eastern / Central / Mountain / Pacific / Alaska / Hawaii /Samoa/ Newfoundland / Atlantic).

【Daylight Saving Time】

Set the daylight saving time for your area.

Press◀/▶ button to select (On / Off).

【Time Format】

Select your time format.

Press◀/▶ button to select (12-hour / 24-hour).

【Auto Clock】

Use to synchronize the display automatically. This is only available in DTV

Press◀/▶ button to select (On / Off).

TV

Setup Menu

Press **MENU** to enter the Main menu, Press ◀/▶ button to select.
Press **ENTER** / ▼ to enter.
Press **MENU** again to exit or return to the Main menu.



Press ▼ / ▲ button to select among Menu Language / Transparent / OSD Timeout / Closed Caption / Over Scan/ Input Label / Other Settings / Restore Default / Setup Wizard. Press **ENTER** / ▼ to enter.
Press ◀/▶ button to adjust.
Press **MENU** again or return to the Main menu.

【Menu language】

Select an OSD menu language to be displayed. English is selected as the default menu language.
Press ◀/▶ button to select language(English / Français / Español).

【Transparent】

Adjust the transparency of the OSD (on screen display) menu. Press ◀/▶ button to select.
(0%, 25%, 50%, 75%, 100%)

【OSD Time out】

Adjust the duration of the OSD (on screen display) menu.
Press ◀/▶ button to select.(5 Sec., 15Sec., 30Sec., 45Sec., 60Sec.)

【Closed Caption】

Adjust Closed Captioning settings. Only available under TV and AV source. Press **ENTER** / ▶ button to enter.

For detail please refer to following page.

TV

Close Caption

【CC Mode】

Turn Closed Captioning on/off.

Press ◀/▶ button to select (CC Off / CC On / CC On / Mute).

【Analog CC】

Set Closed Captioning for standard (analog) program.

Press ◀/▶ button to select (CC1 / CC2 / CC3 / CC4 / TEXT1 / TEXT2 / TEXT3 / TEXT4).

【Digital CC】

Set Closed Captioning for digital program.

Press ◀/▶ button to select (Off / Service1 / Service2 / Service3 / Service4 / Service5 / Service6).

【Option】

Adjust the digital Closed Captioning setting.

Press ▶ button to enter.

【Mode】

Set the look of digital Closed Captioning. Automatic uses broadcaster's style. Press ◀/▶ button to select (Default / Custom).

【Font Style】

Select from 8 font styles.

Press ◀/▶ button to select (Default / Font 0 / Font 1 / Font 2 / Font 3 / Font 4 / Font 5 / Font 6 / Font 7).

【Font Size】

Adjust the size of the digital Closed Captioning font. Press ▼ button to select (Default / Normal / Large / Small).

【Font Edge Style】

Adjust the edge of the digital Closed Captioning box.

Press ◀/▶ button to select (Default / None / Raised / Depressed / Uniform / Left Shadow / Right Shadow).

【Font Edge Color】

Adjust the color of the digital Closed Captioning box.

Press ◀/▶ button to select (Default/ Black / White / Red / Green / Blue / Yellow / Magenta / Cyan).

【FG Color】

Adjust the color of the digital Closed Captioning font.

Press ◀/▶ button to select (Default/ Black / White / Red / Green / Blue / Yellow / Magenta / Cyan).

【BG Color】

Adjust the digital Closed Captioning background color.

Press ◀/▶ button to select (Default/ Black / White / Red / Green / Blue / Yellow / Magenta / Cyan).

【FG Opacity】

Adjust the transparency of the digital Closed Captioning font.

Press ◀/▶ button to select (Default / Solid / Flashing / Translucent).

【BG Opacity】

Adjust the digital Closed Captioning background transparency.

Press ◀/▶ button to select (Default / Solid / Flashing / Translucent).

TV

【Over Scan】

Press ◀▶ button to select (On / Off).

It is only available to enter 1080i/720p/1080p in DTV/Component/HDMI when Default is On. It presets to On in ATV/AV. It presets to Off in PC/USB.

【Input Labels】

Create labels for the devices connected to your TV. Press ENTER / ▶ button to enter.



【Other Settings】

Set the parameter of audio only. Press ENTER / ▶ button to enter.



【Blue Screen】

To select the transition type preferred while changing from one channel to another. Press ◀▶ button to select (On / Off).

【Audio Only】

Play the audio with the picture turned off. When you turn the Audio only on and exit the OSD menu, the panel will be dark; then press any key to exit the Audio Only status.

Press ◀▶ button to select (On / Off).

TV

【Restore Default】

Change power on options or reset TV to factory default.
Press **ENTER/▶** button to enter.

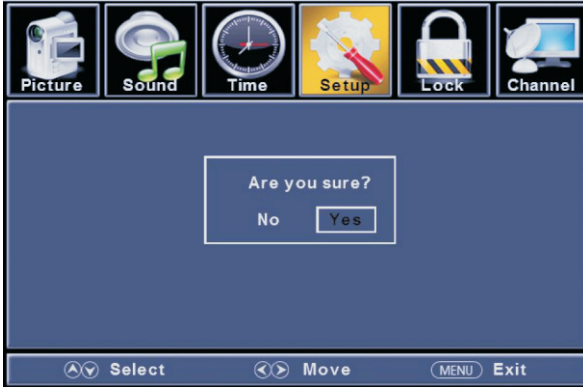

【Setup Wizard】

Reset to first time installation.
Press **ENTER/▶** button to enter.
For detail please refer back to the Setup Menu instructions, page 11.

TV

Lock Menu

Press **MENU** to enter the Main menu, Press **◀▶** button to select.
Press **ENTER / ▼** to enter.
Press **MENU** again to exit or return to the Main menu.



Press **▼ / ▲** button to select Change Password / System Lock / Input Block / US Rating / Canada Rating / RRT Setting / Reset RRT/Hotel menu
Press **ENTER / ▼** to enter.
Press **◀▶** button to adjust.
Press **MENU** again or return to the Main menu.

Enter your 4-digit password. The default password is 0000, and if you forget your password, please call Customer Service at **1-855-692-9192** for assistance.

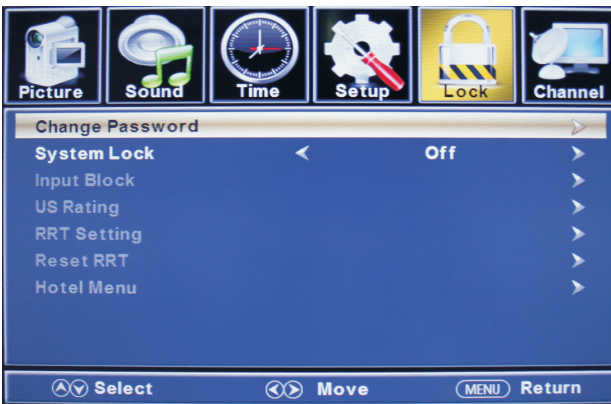

TV

【Change Password】

Enter a new 4-digit password then re-enter it to confirm.
Press ► button to enter.

【System Lock】

Lock or unlock the buttons on the TV. Press ◀/▶ button to select (Off / On).

【Input Block】

Block or unblock the input sources.
Press ► button to enter.
Press ◀/▶ button to select (Unblock / Block).



【US Rating】

Restrict movie and TV programs by US Ratings. Only available when "System Lock" is "on".
Press ► button to enter.
For detail please refer to page 25-26

【RRT Setting】

Display an advance V-Chip rating table for digital channels.
The item is available only when current stream has downloadable rating data.

【Reset RRT】

Reset the RRT to default.
The item is available only when current stream has downloadable rating data.

【Hotel Menu】

Press ► button to enter.
For detail please refer to page 27.

TV

US Rating

For the United States, the rating settings include the following options: TV, MPAA.

TV

The TV rating is composed of two aspects: age-based and content-based.



Age	Define
TV-Y	All children
TV-Y7	7 years old and above
TV-G	General audience
TV-PG	Parental guidance
TV-14	14 years old and above
TV-MA	17 years old and above

*Note:

The content ratings will increase depending on the level of the age-based rating. For example, a program with a TV-PG V (violence) rating may contain moderate violence, while a TV-14 V (violence) rating may contain intense violence. So locking a higher level option will automatically unlock options that have more sensitive levels.

TV

MPAA

This system defines the rating control which come from MPAA rules.

Rating	Define
G	General audience. All ages admitted.
PG	Parental guidance suggested. Some material may not be suitable for children.
PG-13	Parents strongly cautioned. Some material may be inappropriate for children under 13.
R	Restricted. Children under 17 require accompanying parent or adult guardian.
NC-17	No one 17 and under admitted.
X	Adult audience only.
Off	No Rating Set

TV

Hotel Menu



【Hotel Mode】

Set hotel mode On or Off.

Note: The following settings work only when Hotel Mode is set to be On.

【Boot Setting】



【Picture Mode】

Adjust picture mode to change picture appearance.

Press ◀/▶ button to select (Standard / Dynamic / Soft / User).

【Default Volume】

Set the default volume for every time you open the TV, the default volume is 20.

【Max Volume】

Set the max volume that you can adjust.

【Boot Source】

Set the default input source when turning on your TV.

TV

【 Boot Channel 】

Set boot channel On or Off.

Note: Channel Select is available when Boot Channel is set to be On.

【 Channel Select 】

Set boot default on selected channel, after channel search has been completed.

【 Hotel Lock 】

To lock the Tuner/Key Pad/Menu set Tuner Lock to On.

Channel searching is invalid when Tuner Lock is On.

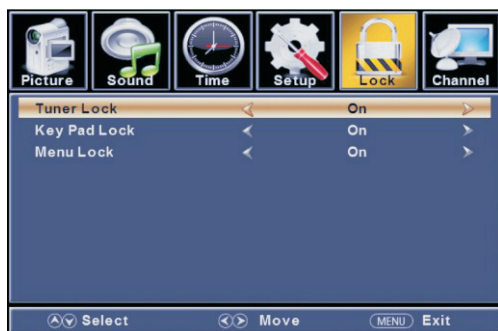

【 Power Save 】

Set the timer for the TV to turn off automatically.

Available Timer: 60Min, 120Min, 180Min, 240Min, Off

【 TV to USB 】

Backup data to USB.

【 USB to TV 】

Restore data from USB.

【 Reset Hotel Setting 】

Recall the default settings of Hotel menu.

TV

Channel Menu

Press **MENU** to enter the Main menu, Press ◀/▶
Press **ENTER** / ▼ to enter ◀/▶ button to select.
Press **MENU** again to exit or return to the Main menu.



Press ▼ / ▲ button to select Air/Cable / Auto Scan / Favorite / Channel List / Show/Hide / Channel Number / Channel Label .
Press **ENTER** / ▼ to enter.
Press ◀/▶ button to adjust.
Press **MENU** again or return to the Main menu.

【Air/Cable】

Select signal type.
Press ◀/▶ button to select (Air/Cable).

【Auto Scan】

Automatically search for channels.
Press **ENTER** / ▶ button to enter.

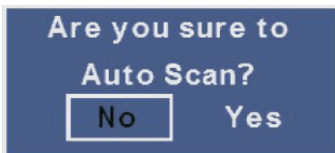

TV

【Favorites】

Add channels to create a favorite list. Press ► button to enter.

【Channel List】

Display your program list. Press ► button to enter.

【Show/Hide】

Show or hide the channels in your program list. Press ► button to enter.



【Channel Number】

Show the channel number.
Press ◀ / ▶ button to adjust.

【Channel Label】

Create labels for channels, up to 7 characters.
Press ◀ / ▶ button to adjust.



PC

PC Menu

Press **INPUT** to select PC source.

Press **MENU** to enter the Main menu, Press ◀/▶ button to select Setup menu.

Press ▼ to select PC Settings.



Press ▼ / ▲ button to select H-Pos / V-Pos / Clock / Phase / Auto.

Press **ENTER** / ▼ to enter.

Press ◀/▶ button to adjust.

Press **MENU** again or return to the Main menu.



PC

【H-Pos】

Adjust the horizontal position of the picture. Press ◀/▶ button to adjust.

【V-Pos】

Adjust the vertical position of the picture. Press ◀/▶ button to adjust.

【Clock】

Adjust the vertical **interfering lines**. Press ◀/▶ button to adjust.

【Phase】

Adjust the horizontal interfering lines. Press ◀/▶ button to adjust.

【Auto】

Adjust the screen automatically to the optimal position of the picture.
Press ▶ button to enter. You may press the AUTO button on the remote.

***Notes:**

1. Color, Tint, Sharpness, Noise Reduction, Dynamic Contrast and HDMI Mode in PICTURE are invalid.
2. MTS and Audio Language in the SOUND menu are invalid.
3. Auto Clock in TIME menu is invalid.
4. Closed Caption in SETUP menu is invalid.
5. US Rating, Canada Rating, RRT Setting and Reset RRT in LOCK menu are invalid.
6. PC mode has no CHANNEL menu.

DVD

Press the “D.Setup” button to enter the DVD settings menu, use the “◀/▶” buttons to select the desired menu page (General / Audio / Video / Preferences), and use “▼/▲” buttons to select the items in each menu, then use “▶” button to enter the selected item. If you change any setting, press “ENTER” button to confirm your selection. Press the “◀” button to return to the sub menu, to go back up to one of the main DVD menu pages, press the “EXIT” button.

1.General Setup Page

OSD Language: Set the language of the setup menu and screen display.

Screen saver: Set the screen protection.

Last Memory: Remember and resume from the position of the previous playback.

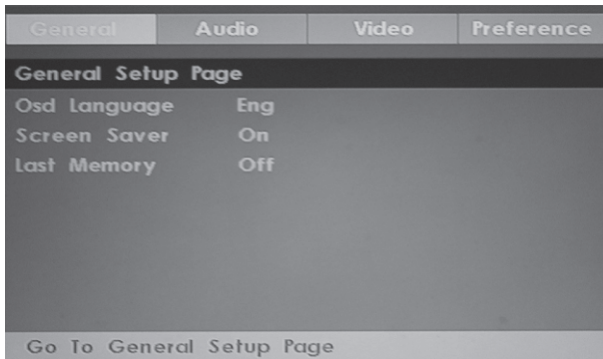

2.Speaker Setup Page

Downmix: This is for DVD L/R and stereo output, factory default is set to Stereo output.

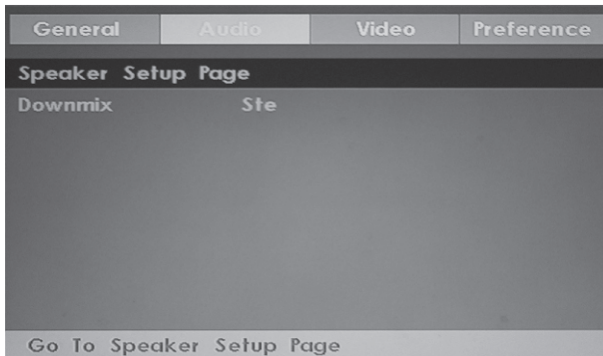

DVD

3.Video Setup Page

Sharpness: Allows adjustment of the sharpness of the image.

Brightness: Allows adjustment of the brightness of the image.

Contrast: Allows adjustment of the contrast of the image.

General	Audio	Video	Preference
Video Setup Page			
Sharpness	Mid		
Brightness	00		
Contrast	00		
Go To Video Setup Page			

4.Preference Page (Note: This menu page will pop up before a disc is inserted into the DVD mechanism.)

TV Type: Select the local TV system (PAL TV/Multi/NTSC TV). Factory default is set to NTSC for use in North America.

Audio: Disc audio language selection may be allowed, dependent upon the disc inserted.

Subtitle: Disc subtitle language selection may be allowed, dependent upon the disc inserted.

Disc Menu: Disc Menu language selection may be allowed, dependent upon the disc inserted.

Parental: Set the maximum disc rating (OFF/G/PG/PG13/R/NC17/X-ADULT) that can be viewed without a password. (default password is 0000)

Password: Allows user to change the password.

Default: Choose this to restore the original default Preference settings

General	Audio	Video	Preference
Preference Page			
TV Type	NTSC		
Audio	Eng		
Subtitle	Off		
Disc Menu	Eng		
Parental			
Password			
Default			
Go To Preference Page			

Help

No Power	Check to see if the AC cord of the television is properly plugged into the outlet. If there is still no power, remove the AC cord and replug after 60 seconds. Attempt to start the television again.
Not receiving signal properly	<ul style="list-style-type: none"> - A double image or ghost could be caused by obstructions of the external antenna. Consult the instruction manual to change the direction of the external antenna. - Perhaps the location of the antenna is not good. Use of a taller antenna can improve the quality of the images. - If you use an indoor antenna, reception may be difficult in some situations. You can attempt to adjust the internal antenna to improve the image. If this does not improve the picture, the external antenna will need to be adjusted.
No Picture	<ul style="list-style-type: none"> - Check to be sure the antenna at the back of the unit is connected properly. - Try to select other channels to be sure the issue is not with the channel. - Check for possible sources of interference.
Poor sound or no sound	<ul style="list-style-type: none"> - Increase the volume. - Check to be sure the unit is not in MUTE mode. Press the mute button to restore sound. - Try to select other channels to be sure the issue is not with the channel. - Check for possible sources of interference. - Check to be sure the antenna at the back of the unit is connected properly.
Poor color or no color	<ul style="list-style-type: none"> - Adjust the contrast and/or brightness of the TV. - Try to select other channels to be sure the issue is not with the channel. - Check to be sure the antenna at the back of the unit is connected properly.
Poor reception	Check to be sure the antenna at the back of the unit is properly connected.
Horizontal or diagonal lines on screen	<ul style="list-style-type: none"> - Unit could be experiencing interference from other appliances such as a hair dryer or vacuum. Discontinue the use of these other appliances to improve reception. - Check to be sure the antenna at the back of the unit is connected properly.
TV does not respond to the remote	- Point the remote directly to the sensor on the TV. If this does not work, be sure that the remote is in working order (batteries correctly installed, etc.)
No Video in PC mode	<ul style="list-style-type: none"> - Check if the display cable is properly connected to the VGA input. - Check to be sure the display cable is not bent or damaged.
The screen is too dark or too light in PC mode	Adjust the contrast ratio or brightness in Main menu.
No response in PC mode	Check the computer setting for compatible display resolutions.
Lines in picture while using RCA connection	<ul style="list-style-type: none"> - Check if the cable is properly connected to the input. - Check to be sure the cable is not bent or damaged. - Use a correct RCA cable.
Problems still exist	Unplug the power cord and wait for 60 seconds, then reconnect. If problems remain with the unit, please do not attempt the repairs yourself. Contact the Customer Service center for assistance.

Help

DVD	
Playback doesn't start or disc ejects automatically.	<ul style="list-style-type: none"> - No disc is inserted. - The disc may be dirty. Clean up the disc. - The disc is scratched or warped. - The unit cannot play CD-ROMs, etc.
Picture is distorted during CUE or REVIEW.	<ul style="list-style-type: none"> - The picture will be distorted occasionally.
Stopping playback, search, slow-motion play, repeat play, or program play, etc. cannot be performed.	<ul style="list-style-type: none"> - Some discs may not allow some functions.
The unit or remote operation key is not functioning.	<ul style="list-style-type: none"> - Turn off the unit and unplug the AC power cord for several minutes, then replug it.
Playback does not start when the title is selected.	<ul style="list-style-type: none"> - Check the Parental Lock setup.
Audio soundtrack and/or subtitle language is not changed when you play back a DVD.	<ul style="list-style-type: none"> - Multilingual language is not recorded on the DVD disc.
No subtitle.	<ul style="list-style-type: none"> - Some discs have no subtitles.

Specifications

Screen Size	TV System	Preset Channels	Speaker Output
24"	NTSC	NTSC:AIR 2-69 CABLE1-125	5W+5W
28"	NTSC	NTSC:AIR 2-69 CABLE1-125	8W+ 8W
32"	NTSC	NTSC:AIR 2-69 CABLE1-125	10W+10W
39"	NTSC	NTSC:AIR 2-69 CABLE1-125	10W+10W
42"	NTSC	NTSC:AIR 2-69 CABLE1-125	10W+10W
50"	NTSC	NTSC:AIR 2-69 CABLE1-125	10W+10W

Screen Size	power Consumption (LED)	Main accessories
24"	48W	User's manual x1 Remote controller x1 Power cord x1 AAA Batteries x2
28"	36W	
32"	56W	
39"	75W	
42"	85W	
50"	135W	

Remote Controller

SLEEP: Select amount of time before TV turn off automatically.

S.MODE: Press to cycle through the different sound settings

P.MODE: Press to cycle through the different picture settings

THUMBSTICK (\leftarrow \rightarrow \uparrow \downarrow / ENTER)
Allows you to navigate the on-screen menus and adjust the system settings to your preference.

MTS: Press to select the audio mode, you can select Stereo, Mono, or SA P(second audio program).

ASPECT: Aspect function.

D.Setup: DVD system setup.

CH +/- : Press to scan through or to select a channel.

V +/-: Press to increase / decrease the sound level.

FAV
Add or delete the current channel as a favorite channel

FAV+ Move down to a favorite program

FAV- Move up to a favorite program

▲ DVD eject

|| Play/Pause DVD program.

■ Stop DVD program.

D.MENU: DVD disc menu, press this to access the menu.

D.TITLE: Press to select the DVD title.

GOTO: Play your favorite title/chapter/track.

D.DISP: Press to display the source and channel's info.

PROG
Press this button to change the playback order. It varies according to the different discs.

STEP: Play for single frame image

REPEAT Repeat playing the title or chapter.

A-B During the playback, press this button to repeat playback of a specific section on a disc.

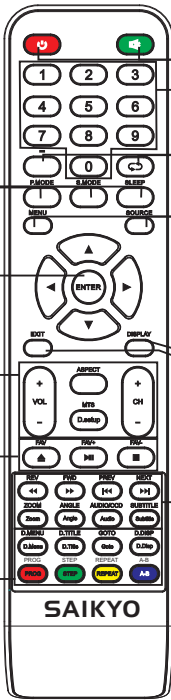

POWER
Set your TV to power on or standby mode.

MUTE
Press to mute the sound. Press again or press VOL+ to unmute.

NUMBER BUTTONS
Press 0-9 to select a TV channel directly when you are watching TV. The channel change after 2 seconds.

-
Press "-" to enter a program number for multiple program channel, such as 2-1 etc.

↶
Return to the previous channel viewed.

MENU
Allows you to navigate the on-screen menus.

SOURCE
Press to cycle through the input source in following:
TV → AV → YPbPr → DVD → HDMI → PC

DISPLAY
Press to display the source and channel's information.

EXIT
Exist from the menu or sub-menu and cancel the function in progress (if applicable)

▶▶ DVD next chapter.

◀◀ DVD previous chapter.

◀◀ DVD fast reverse.

▶▶ DVD fast forward.

ZOOM In DVD source adjust DVD picture size

ANGLE Select DVD picture angle.

AUDIO/CCD Select DVD disc language.

P Press to display the closed caption.

SUBTITLE Select DVD disc subtitle.

SAIKYO

limited **WARRANTY**

LED TV/DVD COMBINATION UNIT

ORION warranty this product to be free from manufacturing defects in material and workmanship under normal use and conditions for a period of 1 year from date of original purchase in the United States.

Should service be necessary under this warranty for any reason due to a manufacturing defect or malfunction during the first 12 months from date of original purchase, ORION will provide carry-in service for units with a screen size of 40 inches or below, and in-home service for units 42 inches or greater in screen size by an ORION authorized Independent Service Center at no charge. Also, if an original part fails due to manufacturing defect in material and workmanship within one year from date of original purchase we will replace the defective part, provided the defect or malfunction is verified along with dated proof of purchase.

There are ORION authorized Independent Service Centers located throughout the country. For the one nearest you, DIAL TOLL FREE:1-855-692-9192,ORION will not be liable for damages incurred in shipment of the unit. If there are no ORION authorized Independent Service Centers in your area please call 1-855-692-9192 for assistance.

Note: This warranty is void if the product is:

- (a) Damaged through negligence, misuse, abuse, or accident.
- (b) Used in a commercial application or rentals.
- (c) Modified or repaired by anyone other than an Independent Service Center authorized by ORION to effect warranty repairs to the class of product or by the ORION Factory Service Center.
- (d) Damaged because it is improperly connected to the equipment of other manufacturers.

This warranty does not cover:

- (a) Damage to video disc.
- (b) Damage to equipment not properly connected to the product.
- (c) Costs incurred in the shipping of the product to an ORION authorized Independent Service Center or ORION Factory Service Center.
- (d) Damage or improper operation of unit caused by customer abuse, misuse, negligence, or failure to follow operating instructions provided with the product.
- (e) Ordinary adjustments to the product which can be performed by customer as outlined in the owner's manual.
- (f) Signal reception problems caused by external antenna or cable systems.

THIS WARRANTY IS NON TRANSFERABLE AND APPLIES ONLY TO THE ORIGINAL PURCHASER AND DOES NOT EXTEND TO SUBSEQUENT OWNERS OF THE PRODUCT. ANY APPLICABLE IMPLIED WARRANTIES, INCLUDING THE WARRANTY OF MERCHANTABILITY, ARE LIMITED IN DURATION TO A PERIOD OF THE EXPRESS WARRANTY AS PROVIDED HEREIN BEGINNING WITH THE DATE OF ORIGINAL PURCHASE AT RETAIL AND NO WARRANTIES, WHETHER EXPRESS OR IMPLIED SHALL APPLY TO THIS PRODUCT THEREAFTER. ORION MAKES NO WARRANTY AS TO THE FITNESS OF THE PRODUCT FOR ANY PARTICULAR PURPOSE AND USE.

UNDER NO CIRCUMSTANCES SHALL ORION BE LIABLE FOR ANY LOSS, DIRECT, INDIRECT, INCIDENTAL, SPECIAL, OR CONSEQUENTIAL DAMAGE ARISING OUT OF OR IN CONNECTION WITH THE USE OF THIS PRODUCT.

THIS WARRANTY IS VALID ONLY IN THE UNITED STATES OF AMERICA. THIS WARRANTY GIVES YOU SPECIFIC LEGAL RIGHTS, HOWEVER, YOU MAY HAVE OTHER RIGHTS WHICH MAY VARY FROM STATE TO STATE. SOME STATES DO NOT ALLOW LIMITATION ON IMPLIED WARRANTIES OR EXCLUSION OF CONSEQUENTIAL DAMAGE, THEREFORE THESE RESTRICTIONS MAY NOT APPLY TO YOU.

ORION SALES, INC.
3471 N. UNION DR.
OLNEY, ILLINOIS 62450

Serial # _____

Date of Purchase _____

Place of Purchase _____

Your receipt is required to verify your proof of purchase, please attach a copy of your receipt here for your records.

N° de série # _____

Date d'achat _____

Lieu d'achat _____

Votre reçu vous sera demandé pour vérifier votre preuve d'achat, merci de bien vouloir joindre une copie de votre reçu ici pour vos archives.

