

connex.

MODEL:WMSMCZ3H / WMSMCZ3H-SB

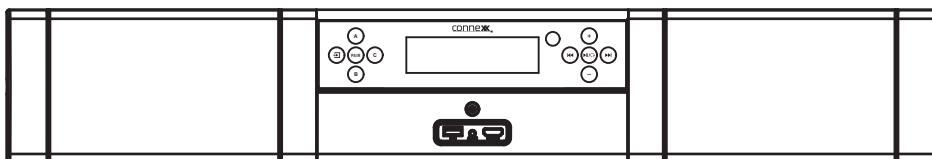
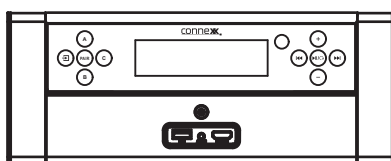

- INSTALLATION AND OPERATION MANUAL -
PLEASE READ INSTRUCTIONS CAREFULLY
AND KEEP FOR FUTURE REFERENCE

TABLE OF CONTENTS

| | |
|---|----|
| INTRODUCTION..... | 3 |
| FEATURES..... | 3 |
| PARTS INCLUDED WITH MAIN UNIT..... | 3 |
| IMPORTANT SAFETY INSTRUCTIONS..... | 4 |
| PLACING AND MOUNTING..... | 6 |
| GENERAL VIEW..... | 7 |
| SPEAKER/POWER WIRE SOCKET DIAGRAM..... | 9 |
| REMOTE CONTROL..... | 10 |
| BATTERY INSTALLATION--REMOTE CONTROL..... | 11 |
| GENERAL OPERATIONS..... | 12 |
| LISTEN TO FM RADIO..... | 13 |
| BLUETOOTH PAIRING AND PLAYBACK..... | 14 |
| ADDING OPTIONAL EXTERNAL SUBWOOFER..... | 15 |
| CONNECT USING OPTICAL..... | 16 |
| CONNECT TO TV(ANALOG)..... | 17 |
| CONNECT USING HDMI IN..... | 18 |
| CONNECT USING HDMI OUT..... | 19 |
| AUX IN..... | 20 |
| USB..... | 20 |
| TROUBLESHOOTING GUIDE..... | 21 |
| SPECIFICATIONS..... | 22 |

INTRODUCTION

Thank you for choosing a Connexx product. We hope you will find the instructions in this owner's manual clear and easy to follow. If you take a few minutes to review, you will learn how to use all the features of your new media center for maximum enjoyment.

FEATURES

Features of the WSMCZ3H media center include:

- Digital FM tuner w/10 presets
- Bluetooth wireless technology
- 3 zone audio distribution
- HDMI (ARC) on rear panel
- HDMI IN on front panel
- 3.5 mm aux input jack on front panel
- USB input on front panel w/device charging capabilities
- Digital Optical input on rear panel
- Analog Stereo Input on Rear Panel
- LED backlit controls
- Wireless remote control included

PARTS INCLUDED WITH MAIN UNIT

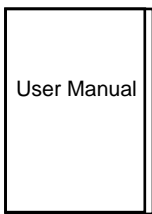

User Manual

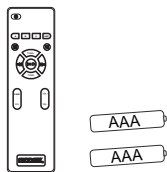

Remote Control with Two Batteries

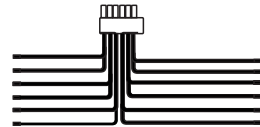

Wire Harness for Speakers

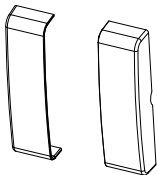

screw cover

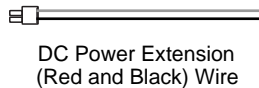

DC Power Extension
(Red and Black) Wire



FM Antenna

IMPORTANT SAFETY INSTRUCTIONS



CAUTION
RISK OF ELECTRIC SHOCK
DO NOT OPEN



CAUTION: TO REDUCE THE RISK OF ELECTRIC SHOCK, DO NOT REMOVE COVER (OR BACK). NO USER-SERVICEABLE PARTS INSIDE. REFER SERVICING TO QUALIFIED SERVICE PERSONNEL.



The lightning flash with arrowhead symbol within an equilateral triangle is intended to alert the user to the presence of uninsulated "dangerous voltage" within the product's enclosure that may be of sufficient magnitude to constitute a risk of electric shock to persons.



The exclamation point within an equilateral triangle is intended to alert the user to the presence of important operating and maintenance (servicing) instructions in the literature accompanying the appliance.

FCC NOTICE:

This equipment has been tested and found to comply with the limits for a Class B digital device, pursuant to part 15 of the FCC Rules. These limits are designed to provide reasonable protection against harmful interference in a residential installation. This equipment generates, uses and can radiate radio frequency energy and, if not installed and used in accordance with the instructions, may cause harmful interference to radio communications. However, there is no guarantee that interference will not occur in a particular installation. If this equipment does cause harmful interference to radio or television which can be determined by reception, turning the equipment off and on, the user is encouraged to try to correct the interference by one or more of the following measures:

- Reorient or relocate the receiving antenna. Increase the separation between the equipment and receiver.
- Connect the equipment into an outlet with a circuit different from that to which the receiver is connected.
- Consult the dealer or an experienced radio/TV technician for help.

FCC WARNING:

To assure continued compliance, follow the attached installation instructions and use only shielded cables when connecting to other devices. Modifications not authorized by the manufacturer may void user's authority to operate this device.



DANGER:

Invisible and hazardous laser radiation when open and interlock failed or defeated. Avoid direct exposure to beam.

WARNING:

TO REDUCE THE RISK OF FIRE OR ELECTRIC SHOCK, DO NOT EXPOSE THIS PRODUCT TO RAIN OR MOISTURE.

WARNING:

TO REDUCE THE RISK OF FIRE OR ELECTRIC SHOCK, AND ANNOYING INTERFERENCE, USE THE RECOMMENDED ACCESSORIES ONLY.

Before using the unit, be sure to read all operating instructions carefully. Please note that these are general precautions and may not pertain to your unit.

1) Read these instructions

All the safety and operating instructions should be read before the product is operated.

2) Keep these instructions

The safety and operating instructions should be retained for future reference.

3) Heed all warnings

All warnings on the product and in the operating instructions should be adhered to.

4) Follow all instructions

All operating and use instructions should be followed.

5) Do not use this apparatus near water

Do not use this product near water and moisture, for example: near a bathtub, washbowl, kitchen sink or laundry tub; in a wet basement; or near a swimming pool.

6) Clean only with dry cloth

Unplug this product from the wall outlet before cleaning. Do not use liquid cleaners or aerosol cleaners. Use a dry cloth for cleaning.

7) Do not block any ventilation openings. Install in accordance with the manufacturer's instructions

Slots and openings in the cabinet and in the back or bottom are provided for ventilation, to ensure reliable operation of the product and to protect it from overheating. These openings must not be blocked or covered. The openings should never be blocked by placing the product on a bed, sofa, rug or other similar surface. This product should never be placed near or over a radiator or heat source. This product should not be placed in a built-in installation such as a bookcase or rack unless proper ventilation is provided or the manufacturer's instructions have been adhered to.

8) Do not install near any heat sources such as radiators, heat registers, stoves, or other apparatus(including amplifiers) that produce heat.

9) Do not defeat the safety purpose of the polarized or grounding-type plug. A polarized plug has two blades with one wider than other. A grounding type plug has two blades and a third grounding prong. The wide blade or the third prong are provided for your safety. If the provided plug does not fit into your outlet, consult an electrician for replacement of the obsolete outlet.

10) Protect the power cord from being walked on or pinched particularly at plugs, convenience receptacles, and the point where they exit from the apparatus.

11) Only use attachments/accessories specified by the manufacturer.

12) Unplug this apparatus during lightning storms or when unused for long periods of time

To protect your product from a lightning storm, or when it is left unattended and unused for long periods of time, unplug it from the wall outlet and disconnect the antenna or cable system. This will prevent damage to the product due to lightning and power-line surges.

13) Refer all servicing to qualified service personnel. Servicing is required when the apparatus has been damaged in any way, such as power-supply cord or plug is damaged, liquid has been spilled or objects have fallen into the apparatus, the apparatus has been exposed to rain or moisture does not operate normally, or has been dropped.

14) Power source

This product should be operated only from the type of power source indicated on the marking label. If you are not sure of the type of power supply to your home, consult your appliance dealer or local power company. For products intended to operate from battery power, or other source, refer to the operation instructions.

15) Service

Do not attempt to service this product yourself as opening or removing covers may expose you to dangerous voltage or other hazards. Refer all servicing to qualified service personnel.

WARNING:

To reduce the risk of fire or electric shock, do not expose this apparatus to rain or moisture. The apparatus shall not be exposed to dripping or splashing and that objects filled with liquids, such as vases shall not be placed on apparatus.

PLACING & MOUNTING

1. Placing

When placing the media center in any type of enclosed space, be sure to allow space around it for ventilation.

If placing in a tight space without ventilation, heat generated from the unit could produce a potential heat hazard.

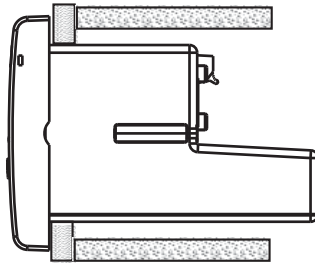

2. Mounting

Rough opening cut-out

(WMSMCZ3H).....10 5/8(Width) x 3 3/4(Height) x 5 5/8(Depth) in

(WMSMCZ3H-SB).....28 3/4(Width) x 3 3/4(Height) x 5 5/8(Depth) in

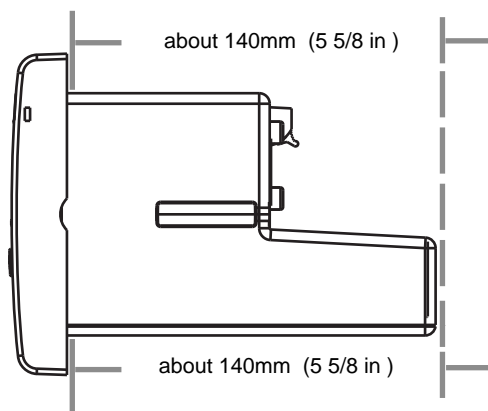

GENERAL VIEW

Front View

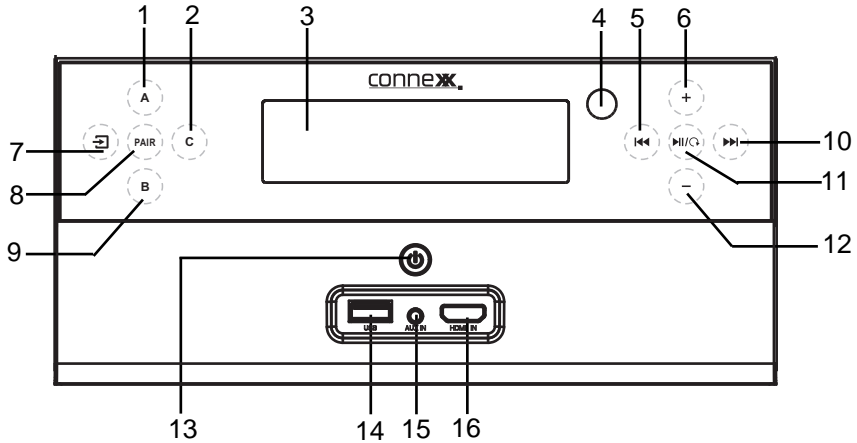

- | | |
|---------------------------|---|
| 1. Zone A touch button | 9. Zone B touch button |
| 2. Zone C touch button | 10. Next touch button |
| 3. Display | 11. Play/pause, Station recall touch button |
| 4. Remote sensor | 12. Volume down touch button |
| 5. Previous touch button | 13. Power on/off button |
| 6. Volume up touch button | 14. USB port |
| 7. Source touch button | 15. AUX IN jack |
| 8. PAIR touch button | 16. HDMI IN port |

Display

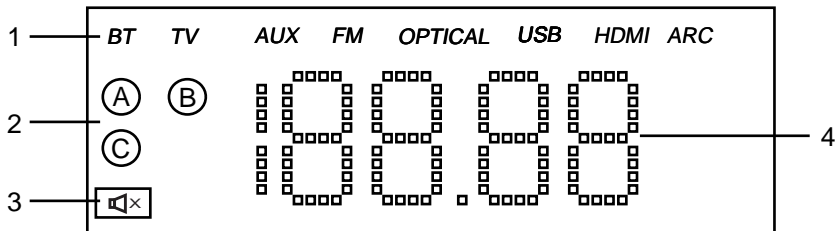

- | | |
|---------------|-----------------|
| 1. Mode | 3. Mute |
| 2. Audio zone | 4. FM frequency |

Rear View

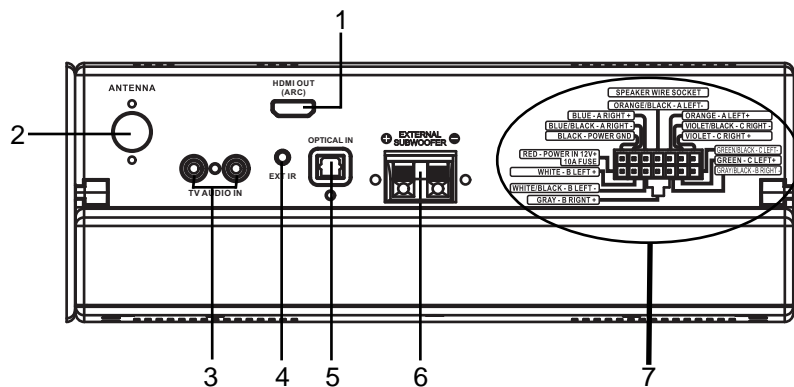

1. HDMI OUT (ARC) jack
2. ANTENNA jack
3. TV AUDIO IN jacks
4. EXT IR jack

5. OPTICAL IN jack
6. EXTERNAL SUBWOOFER connector
7. Power/speaker wire harness socket

SPEAKER/POWER WIRE SOCKET DIAGRAM

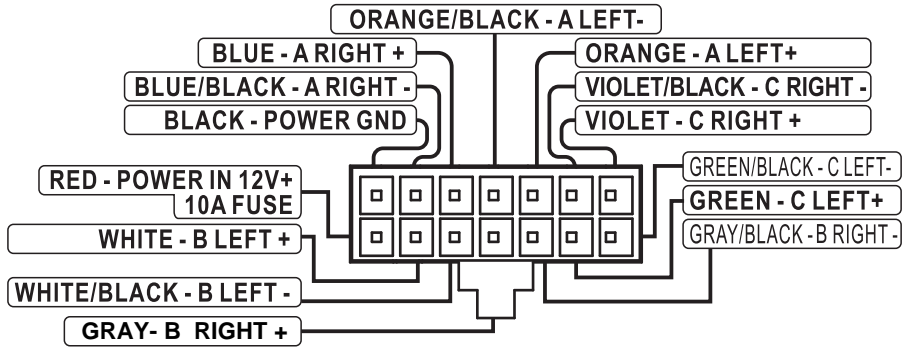

SPEAKER (6X4-ohms) WIRING COLOR CODE GUIDE

CAUTION!
Connecting the speakers incorrectly will cause distortion and damage the power amplifier.

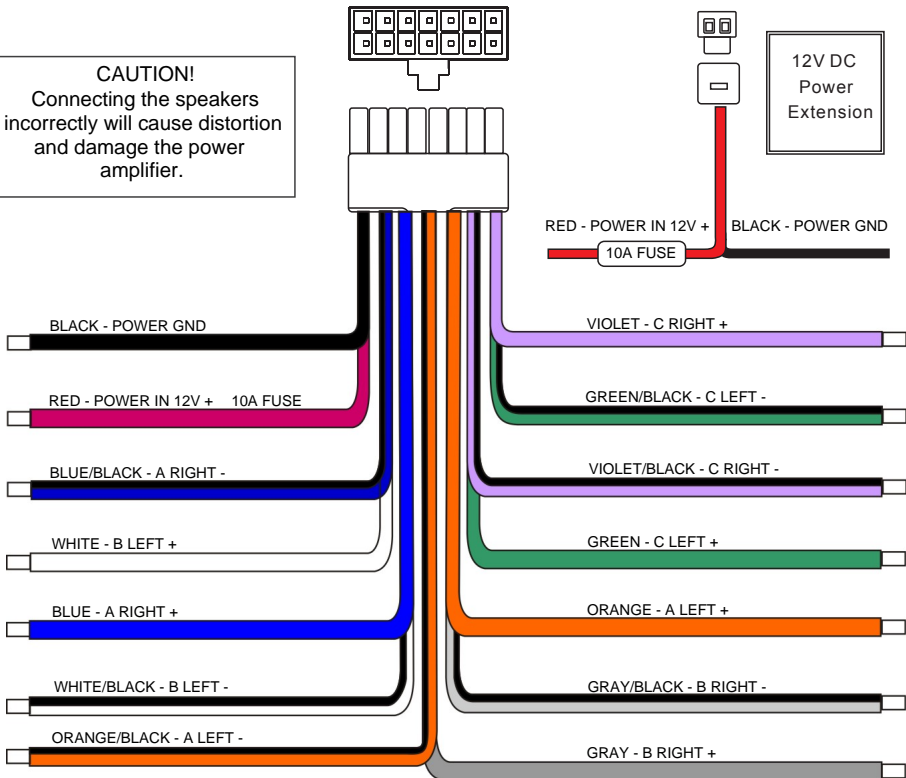

REMOTE CONTROL

1. Power on/off button
2. Zone A button
3. Zone B button
4. Source button
5. TUNE + button
6. Previous button
7. TUNE - button
8. PAIR button
9. EQ button
10. ARC (audio return channel) button
11. Zone C button
12. Mute button
13. Next button
14. Play/pause, preset button
15. VOL+,VOL- button

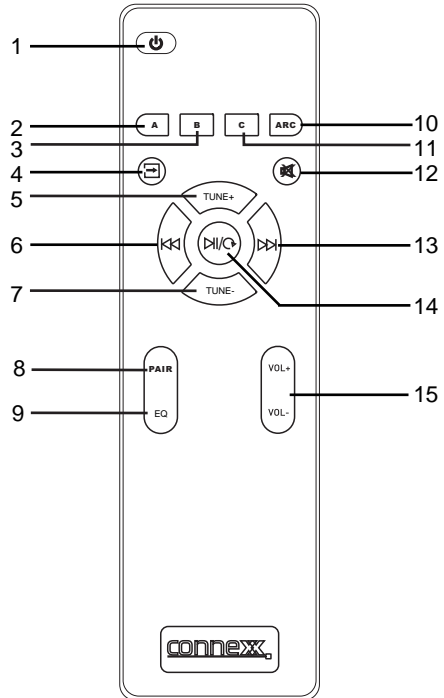

Optional External Remote Sensor

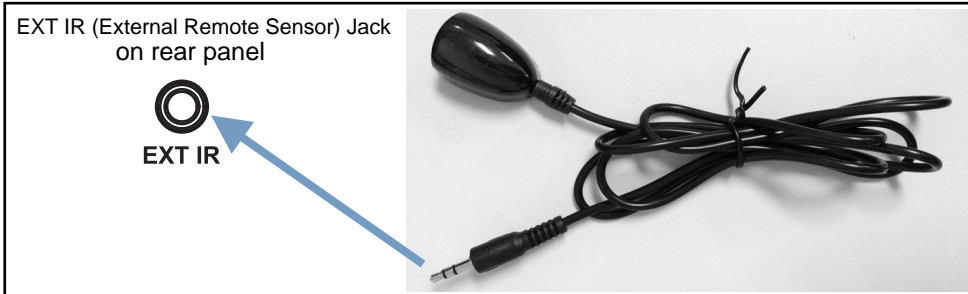

If using the external optional remote sensor, insert the plug into the EXT IR Jack as the arrowhead shown on above picture. This will allow the remote control to work in another zone if desired.

BATTERY INSTALLATION--- REMOTE CONTROL

Battery Installation

1. Slide and lift the battery door (Figure 1).
2. Install 2 (two) AAA size batteries into the battery compartment as indicated by the polarity markings (Figure 2).
3. Replace the battery door (Figure 3).

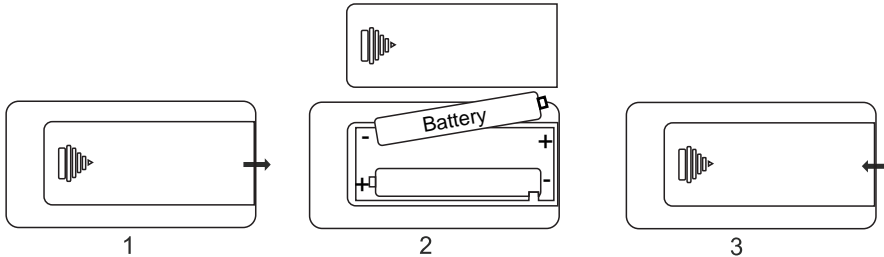

Battery Precaution

Follow these precautions when using a battery in this device:

1. Use only the size and type of battery specified.
2. Be sure to follow the correct polarity when installing the battery as indicated in the battery compartment. A reversed battery may cause damage to the device.
3. Do not mix different types of batteries together (e.g. Alkaline and Carbon-zinc) or old batteries with fresh ones.
4. If the batteries in the device are consumed or the device is not to be used for a long period of time, remove the batteries to prevent damage or injury from possible battery leakage.
5. Do not try to recharge the battery not intended to be recharged; it can overheat and rupture. (Follow battery manufacturer's instructions).
6. The batteries shall not be exposed to excessive heat such as sunshine, fire, or the like.
7. Clean the battery contacts and also those of the device prior to battery installation.



Remote Control Effective Range

Notes:

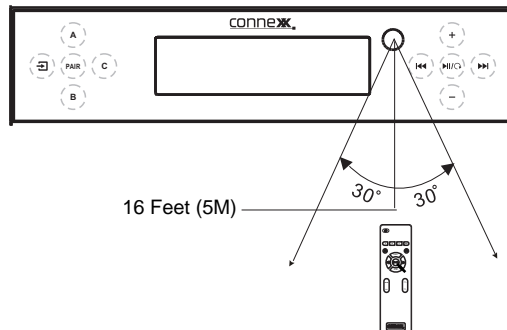
- When there is an obstacle between the unit and the remote control, the remote control may not operate properly.
- When direct sunlight, an incandescent lamp, fluorescent lamp or any other strong light shines on the remote sensor of the unit, the operation of remote control may be unstable.





GENERAL OPERATIONS

1. Press the  button on the unit or remote control to power on the unit from standby mode.
2. Press the  button on remote control or touch the  button on unit repeatedly to switch to desired mode as listed:

BT TV AUX FM OPTICAL USB HDMI ARC

NOTE: USB mode will be selected when the USB device is inserted.

3. During Playback:
 - ~ Press the VOL+/VOL- buttons on the remote control or touch the + or - button on the unit to adjust volume level as desired.
 - ~ Press  button on the remote control to mute the sound on all active zones. Press again to resume.
 - ~ Press A, B or C button on the remote control or touch A, B or C button on the unit to switch ON or OFF the corresponding ZONE A/B/C speakers.
 - ~ Press the EQ button on remote control repeatedly to set to different EQ mode.
4. When finished listening, press the  button on the unit or remote control to power off the unit.
5. If the unit is not used for long period of time, please disconnect power.





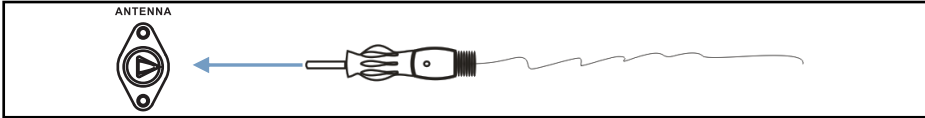

LISTEN TO FM RADIO

BEFORE OPERATION



Insert the Antenna into the ANTENNA Jack on rear panel as illustrated as below.





SEARCHING STATION

1. Power ON the unit.
2. Press the  button on remote control or touch the  button on unit repeatedly to switch to FM mode, the FM frequency will appear on the display.
3. Touch and hold the  or  button on front of the unit or press and hold the TUNE- or TUNE + button on remote control, then release the button to search the previous or next available FM station automatically, when a station searched, it will playback automatically.
4. Touch the  or  button on front of the unit or press the TUNE- or TUNE+ button on remote control to fine tune.



STATIONS STORAGE THROUGH THE TOUCH BUTTON ON UNIT

When a station searched, touch and hold the  button to display the storage location (such as Pxx, the xx stands for 01-10), then press  button to change and select the desired storage location, touch and hold the  button to confirm and complete station storage. A total of 10 stations can be stored into the unit's memory.

STATIONS STORAGE THROUGH THE BUTTON ON REMOTE CONTROL

When a station searched, press and hold the  button to display the storage location (such as Pxx, the xx stands for 01-10), then press the  button to change and select the desired storage location, press and hold the  button to confirm and complete station storage. A total of 10 stations can be stored into the unit's memory.



PRESET RECALL

Touch the  button on the unit or press the  on remote control repeatedly to select the preset stored station and playback.

FM Antenna

The antenna wire on the rear of the unit is for radio reception. If reception is weak, unwind and extend the wire or relocate the unit to improve the radio reception.

BLUETOOTH PAIRING AND PLAYBACK

1. Power ON the unit.
2. Press the  button on remote control or touch the  button on unit repeatedly until "BT" appears on display and blinks, now it is in BT pairing mode.
3. Activate the external BT Device and enter BT searching mode. Start pairing as the screen instructions on the external BT Player.
For details pairing procedures, please refer to the user's manual of your BT Device.
4. When the external BT Device searched the unit, **WMSMCZ3H'** will appear on the display of the external BT Device, select it and make connection.
5. After successfully paired and connected, the "BT" on display will stay lit.
6. If you want to connect with other BT device, press the PAIR button on remote control or touch the PAIR button on the unit to disconnect the current pairing and connection, then try to pair and connect with other BT device.

During playback:

Press the VOL+/VOL- buttons on the remote control or touch the + or - button on the unit to adjust volume level as desired.

NOTE:

After pairing for the first time, the unit will remember and automatically pair with the last connected device when the bluetooth of the device and the unit are activated within range.

ADDING OPTIONAL EXTERNAL SUBWOOFER

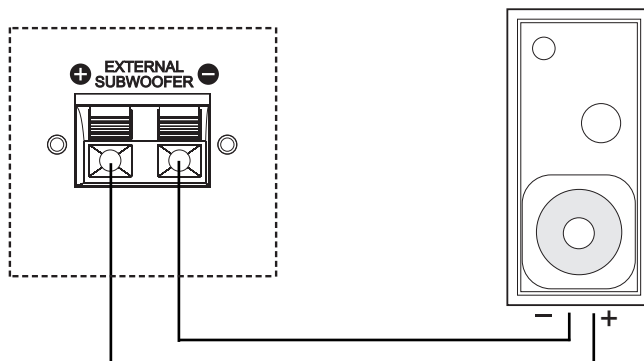



NOTE: Before connecting, please disconnect power.

1. Connect one end of subwoofer connection cable (not supplied) to the "+" Jack on the rear of the unit as the figure above.
2. Connect the other end to the "-" Jack on the rear of the unit as the figure above.
3. Power ON the unit.
4. Play the music as usual and set the desired volume.

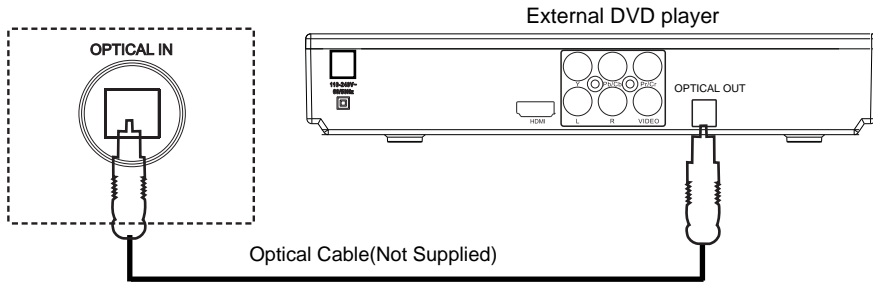
CONNECT USING OPTICAL





NOTE: Before connecting, please disconnect power.

1. Connect one end of optical connection cable (not supplied) to the OPTICAL IN jack on the rear of the unit as pictured above.
2. Connect the other end to the OPTICAL OUT jack on DVD PLAYER.
3. Power ON the unit.
4. Press the  button on remote control or touch the  button on unit repeatedly until "OPTICAL" appears on display.
5. Set the desired volume.

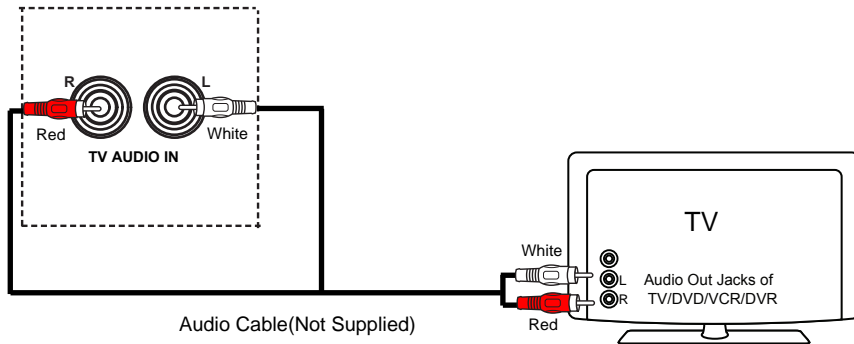
CONNECT TO TV (ANALOG)





NOTE: Before connecting, please disconnect power.

1. Connect as the figure above.
2. Power ON the unit.
3. Press the  button on remote control or touch the  button on unit repeatedly until " TV " appears on display. TV audio is selected and will play through the unit.
4. Play the audio or video as usual and set the desired volume.

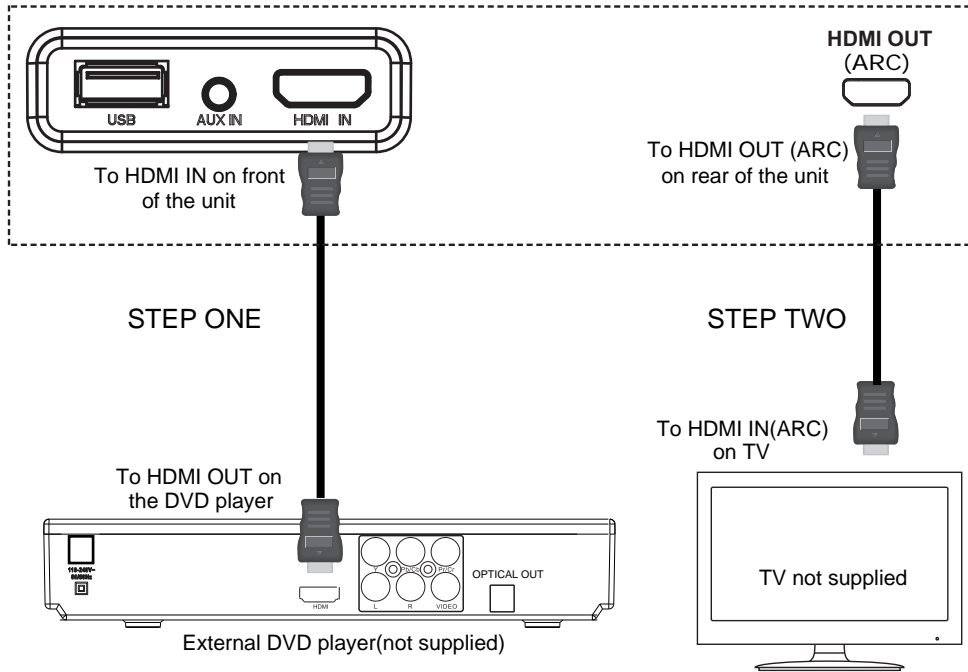
CONNECT USING HDMI IN



NOTE: Before connecting, please disconnect power.

1. Connect as the figure above.
2. Power ON the unit, the external DVD player and the TV.
3. Press the  button on remote control or touch the  button on unit repeatedly until " HDMI " appears on display.
4. Play the audio CD through external DVD player if only connected like STEP ONE.
Play the DVD through external DVD player when connected like STEP ONE and STEP TWO.



NOTE:

- The sound setting in DVD player must be set to PCM format.

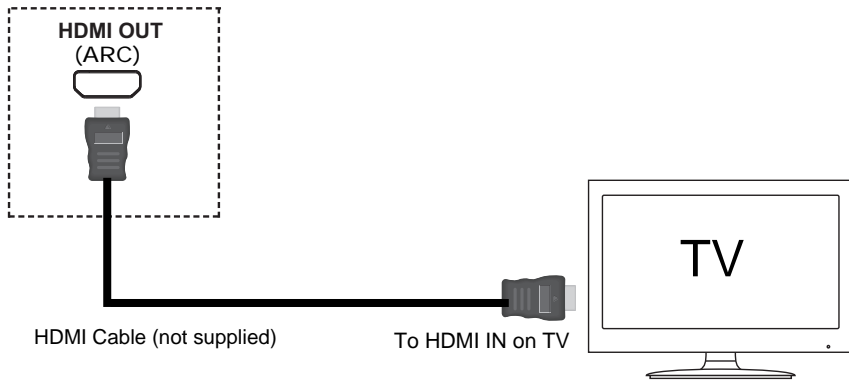
CONNECT USING HDMI OUT



NOTE: Before connecting, please disconnect power.



1. Connect as the figure above.
2. Power ON the unit.
3. Press the  button on remote control or touch the  button on unit repeatedly until " ARC " appears on display.
4. Play the audio or video through TV as usual and set to the desired volume.

NOTE:

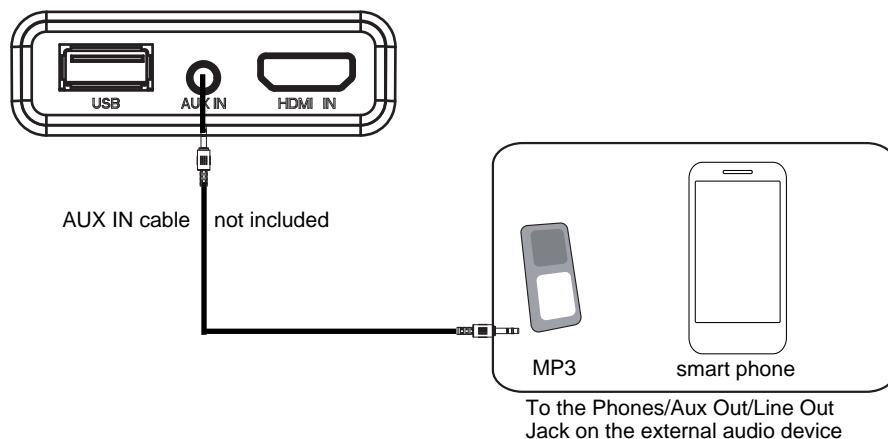

- The TV must have the ARC capability, and connected to HDMI ARC jack on capable TV.
- No matter which mode the unit is in, press the ARC button on remote control to switch back to ARC mode.

AUX IN : LISTEN TO EXTERNAL AUDIO DEVICES



1. Connect one end of audio connection cable to the AUX IN jack on the front of the unit as illustrated above.
2. Connect the other end to the Audio out/Line out/Phone jack on the external player (such as iPod, iPhone, iPad, MP3 player, smart phone... etc.)
3. Power ON the unit.
4. Press the  button on remote control or touch the  button on unit repeatedly until " AUX " appears on display.
5. Play the music in the external player as usual and set the desired volume.

USB : LISTEN TO EXTERNAL AUDIO DEVICES

1. Insert the USB device.
2. Power ON the unit.
3. Press the  button on remote control or touch the  button on unit repeatedly until " USB " appears on display.
4. Play the music in the external player as usual and set the desired volume.

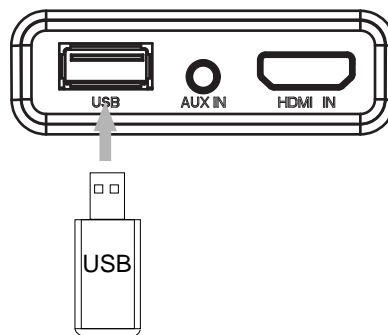

NOTE:

The USB port can also be used for charging the external device.

TROUBLESHOOTING GUIDE

| Check the following guide before requesting service | | |
|---|--|---|
| SYMPTOM | POSSIBLE CAUSE | POSSIBLE SOLUTION |
| No power | power cable not connected or blown fuse | -Check fuse -Check 12V connection |
| No sound | Volume in minimum position | Raise volume level by pressing the VOL (Volume) + button |
| | The connected device is not in playback mode | Play the music/movie in the connected device as usual and make sure the volume level of it is in high level |
| | Input source incorrect | Press the  button repeatedly to set the input source to the desired mode |
| Sound distortion | Bass level of the connected device too high | Reduce the bass level of the connected device |
| | Volume level too high | Reduce the volume level by pressing the VOL (Volume) - button |
| Remote not working | The batteries are consumed | Replace with new batteries |
| Bluetooth reception failure | The external device is too far from the unit | Move the external BT device closer to the unit |
| | Have not paired | Pair both units |

SPECIFICATIONS

| | |
|--------------------------------------|---|
| Operation Voltage..... | DC10V-14V |
| Power Supply Requirement..... | DC 12 Volts, Negative Ground |
| Overall Dimension (WMSMCZ3H-SB)..... | 741.2(W)x122.0(H)x161.0(D)mm |
| Overall Dimension (WMSMCZ3H)..... | 312.0(W)x122.0(H)x161.0(D)mm |
| Max Power Consumption..... | .80W |
| Video In Level..... | 1 Vp-p/Load impedance:75 ohm |
| Radio Coverage | FM 87.5 -108.0 MHz |
| Bluetooth Effective Range..... | Up to 30 feet (Measured in open area. Wall and structures may affect the effective range.) |
| Remote Effective Range..... | Up to 16 feet |

Specifications are subject to change without notice.

FCC WARNINGS:

The device complies with Part 15 of the FCC rules. Operation is subject to the following two conditions.

- (1) The device may cause harmful interference. and
- (2) This device must accept any interference received, including the interference that may cause undesired operation.

Changes or modifications not expressly approved by the party responsible for compliance could void the user's authority to operate the equipment.

NOTE:

THE MANUFACTURER IS NOT RESPONSIBLE FOR ANY RADIO OR TV INTERFERENCE CAUSED BY UNAUTHORIZED MODIFICATIONS TO THIS EQUIPMENT. SUCH MODIFICATIONS COULD VOID THE USER'S AUTHORITY TO OPERATE.

RIVERPARK

www.riverparkinc.com

© 2019 RIVERPARK Inc.

V. 051819